

FIBOX EURONORD Terminal Box

PC-162515

POLYCARBONATE | IP66 | IP67 | IK07 | IK08

160H x 250W x 150D

IP Enclosures, in partnership with FIBOX, offers a premium range of polycarbonate terminal boxes engineered and manufactured in Finland to the highest quality standards. Designed for harsh climate conditions, polycarbonate terminal boxes deliver exceptional dimensional stability, durability, mechanical strength, and electrical insulation. The range is UV-resistant, impact-resistant, chemical-resistant, and flame-retardant, ensuring reliable protection of electrical and electronic components worldwide.

EAN: 6418074058485

Electric Numbers:

- Finland: 3435376
- Denmark: 8212002982
- Sweden: 2536132

ETIM: EC000261

Protection: IP66/IP67, IK07, IK08

Standards (& Conformities): IEC/EN 60529, IEC/EN 62208, IEC/EN 61439-1

Material:

- Body: Polycarbonate
- Cover: Polycarbonate
- Seal/Gasket: Polyurethane

Body: The durable body is constructed from polycarbonate, delivering superior resistance to UV exposure, chemical exposure, flame, and mechanical impact. External edges are rounded and surfaces are polished to improve user safety and to facilitate cleaning and maintenance. It is fully insulated and halogen-free. Multiple mounting options include galvanised steel plates, DIN rails, and wall fastening lugs which simplify installation and support a wide range of electrical components.

Cover: The durable cover is made from polycarbonate and is provided with polyurethane seal. Stainless steel cover screws are provided to facilitate quick locking system.

Seal/Gasket: Polyurethane.

Lock: Stainless steel cover screws. Quick locking system.

Mounting Plate: 1.5mm galvanised steel. (Not included and must be ordered separately).

Standard Colour: RAL7035 Light Grey.

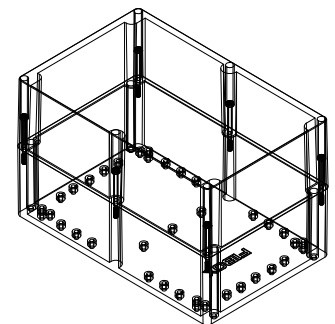
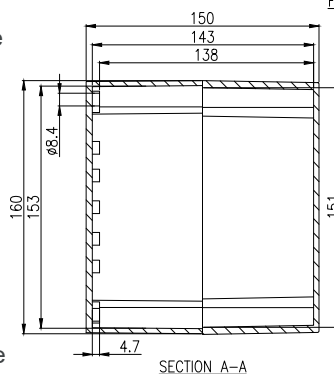
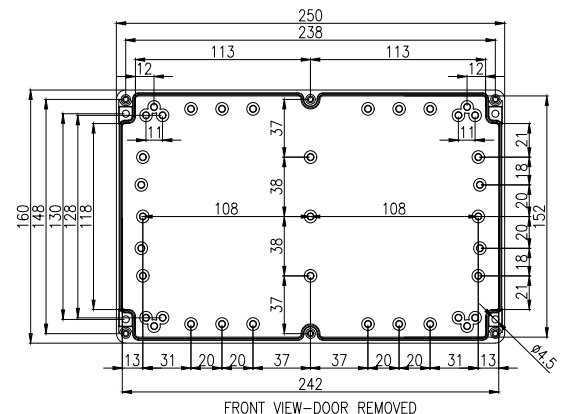
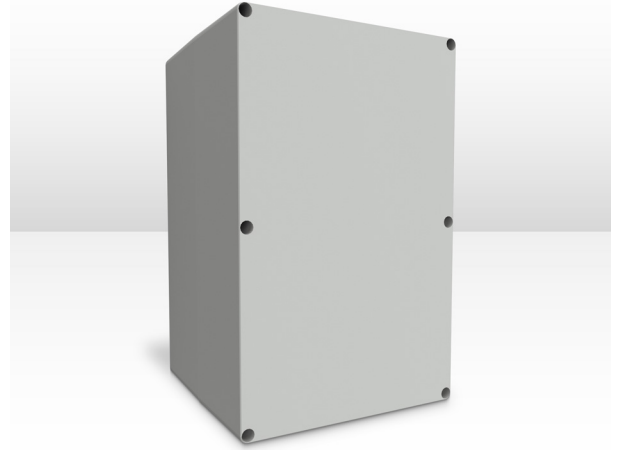

FIBOX EURONORD Terminal Box

PC-162515

POLYCARBONATE | IP66 | IP67 | IK07 | IK08

160H x 250W x 150D

ACCESSORIES:

Part Number	Description
TM 1625	Galvanised Steel Mounting Plate 151mmH x 214mmW x 1.5mmD
TRM 0816	Galvanised Steel DIN-15 Mounting Rail 146mmH x 15mmW x 5mmD
TRH 1216	Galvanised Steel DIN-35 Mounting Rail 146mmH x 35mmW x 7mmD
TRH 24	Galvanised Steel DIN-35 Mounting Rail 226mmH x 35mmW x 7mmD
TH A	Grey Plastic Hinges - 2 pcs. includes Mounting Screws 30mmH x 20mmW x 12mmD

PARAMETERS:

Electrical Insulation:	Fully Insulated
Halogen Free (DIN/VDE 0472, Part 815):	Yes
UV Resistance:	UL 746C
Flammability Rating:	UL 94 V0
Glow Wire Test (IEC 695-2-1)°C:	960°C
Temperature °C (short term use):	-40...+120°C
Temperature °C (continuous term use):	-40...+80°C

CERTIFICATES:

Certificate FI 41298. Our Ref. HEL-CERT210200096-04.