

RevNo	Revision note	Date	Signature	Checked
0	GENERAL REVISION		IP	IP

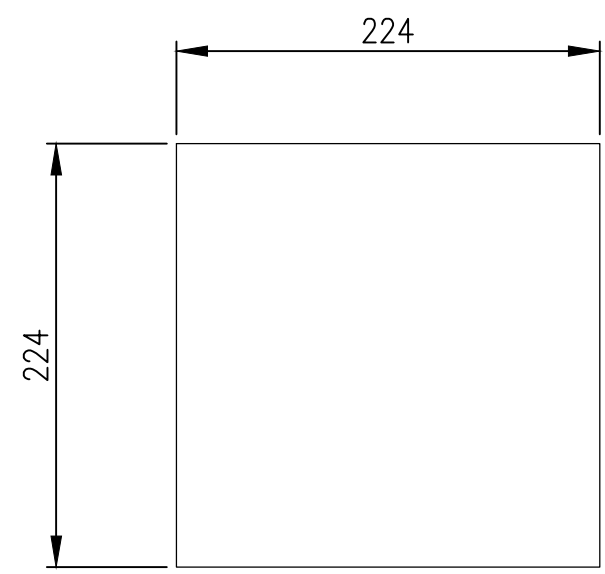

CUT-OUT DIMENSION

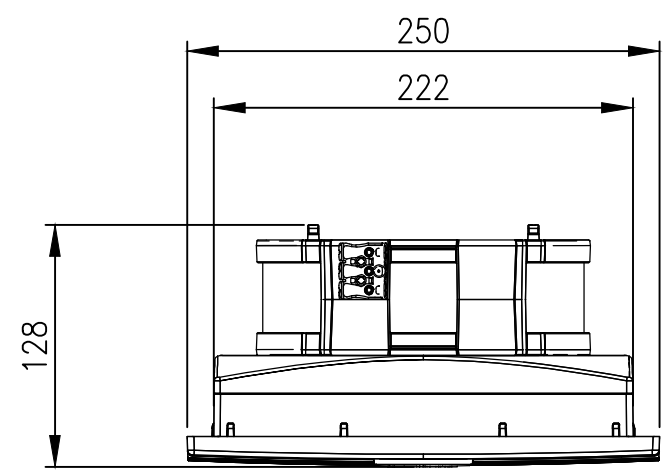

TOP VIEW

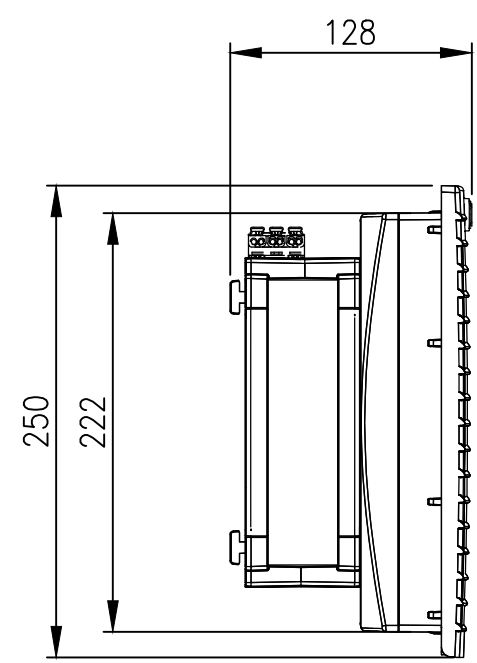
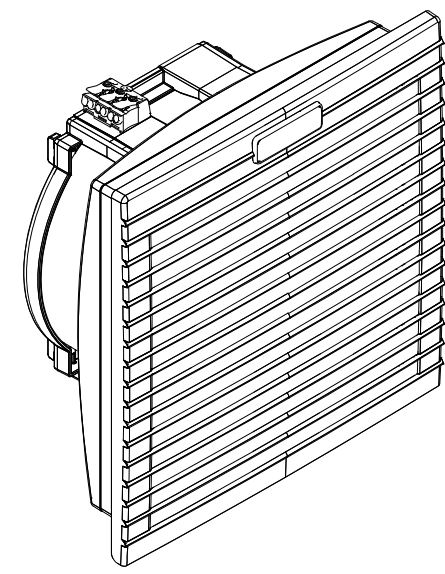

LEFT SIDE VIEW

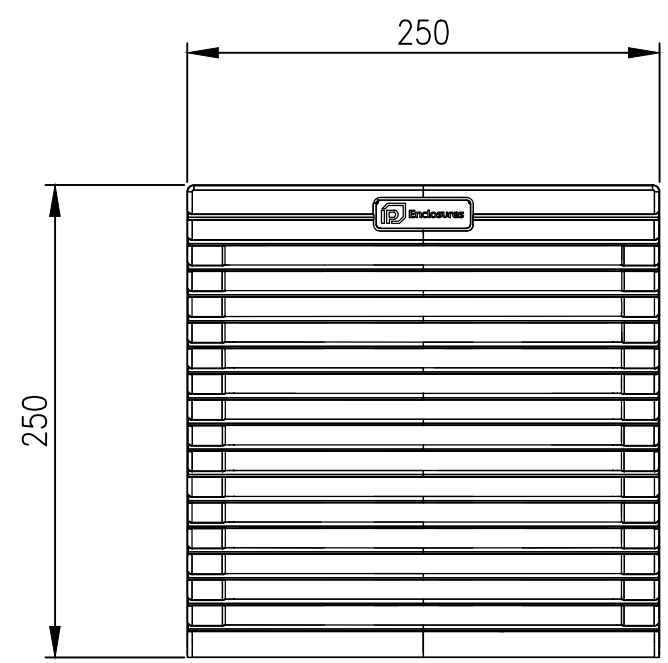

FRONT VIEW

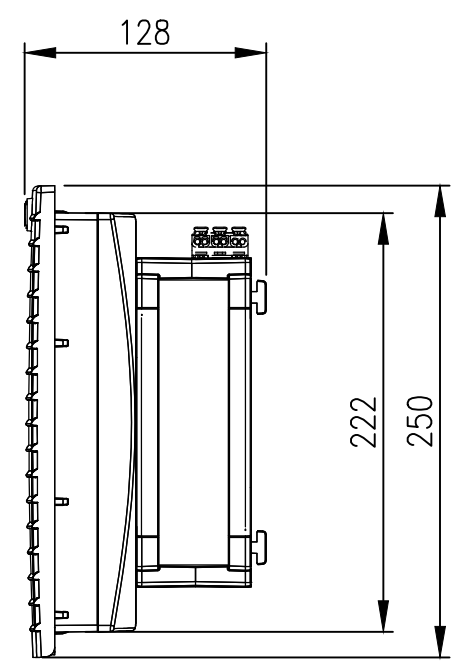

RIGHT SIDE VIEW

MATERIAL
 ALL MOLDED PARTS: ABS, UL94V-0
 WALL THICKNESS: 1.2-2.4mm
 GASKET: FOAM SEAL GASKET
 MOUNTING: FAST CLIP-ON
 FILTER MAT EN779: G3
 STANDARD COLOUR: RAL7035
 AIR FLOW RATE: 255(290)m3/hr
 FAN DIMENSIONS: 250x250x128mm
 CUT-OUT DIMENSIONS: 224x224mm

MASS (WITH PACKAGING): 1.72(1.92)kg.

PROTECTION: IP54/CLASS I

© IP ENCLOSURES 2022.
 THIS DRAWING SHALL NOT BE COPIED OR REPRODUCED
 WITHOUT AUTHORISATION FROM IP ENCLOSURES.
 www.ipenclosures.com.au

Itemref	Quantity	Title/Name, designation, material, dimension etc	Article No./Reference
IP	1	250x250x128 FILTER FAN	IP-V4300
Designed by	Checked by	Approved by - date	Filename
IP	IP		IP-V4300
Date	23/06/22	Scale	1:4
Edition		Sheet	
0		1/1	