

RevNo	Revision note	Date	Signature	Checked
0	GENERAL REVISION		IP	IP

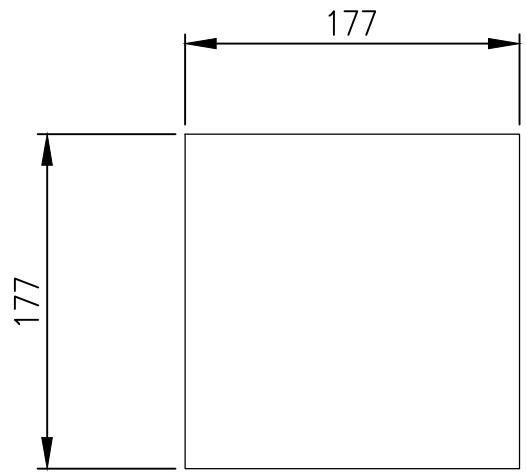

CUT-OUT DIMENSION

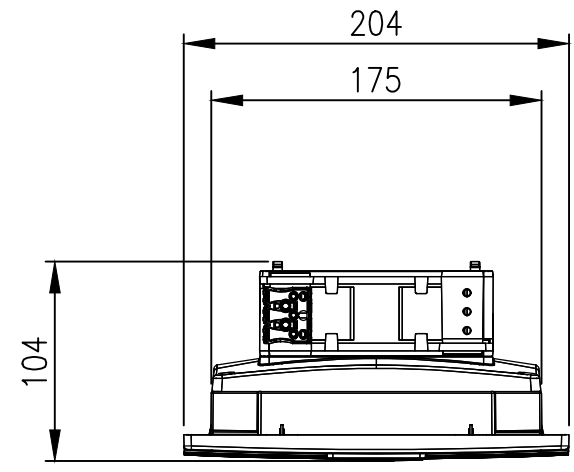

TOP VIEW

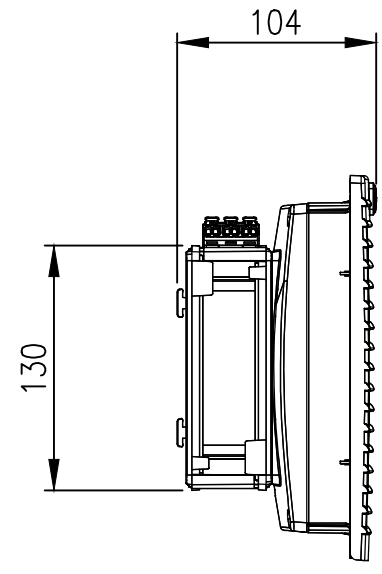
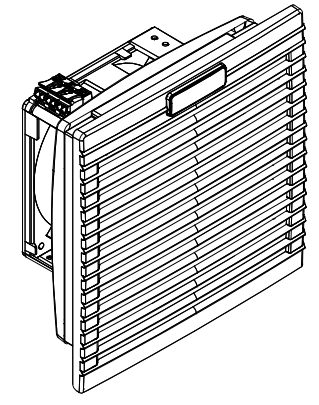

LEFT SIDE VIEW

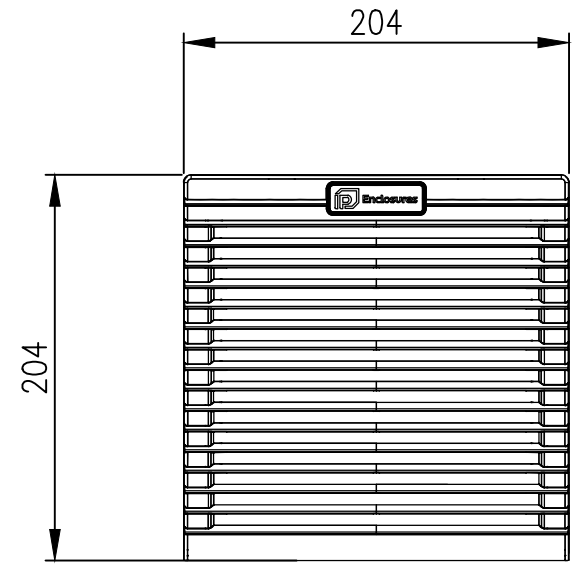

FRONT VIEW

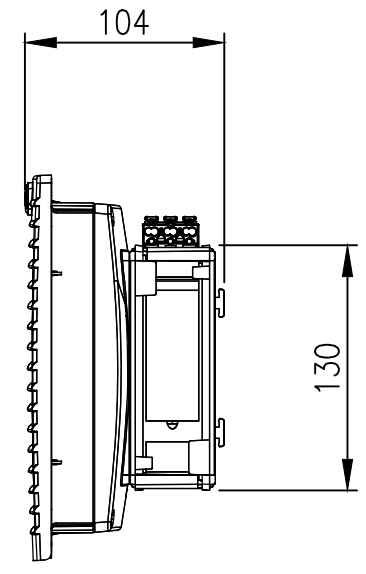

RIGHT SIDE VIEW

**MATERIAL**  
 ALL MOLDED PARTS: ABS, UL94V-0  
 WALL THICKNESS: 1.2-2.4mm  
 GASKET: FOAM SEAL GASKET  
 MOUNTING: FAST CLIP-ON  
 FILTER MAT EN779: G3  
 STANDARD COLOUR: RAL7035  
 AIR FLOW RATE: 115(125)m3/hr  
 FAN DIMENSIONS: 204x204x104mm  
 CUT-OUT DIMENSIONS: 177x177mm

MASS (WITH PACKAGING): 0.98(1.18)kg.

PROTECTION: IP54/CLASS I

© IP ENCLOSURES 2022.  
 THIS DRAWING SHALL NOT BE COPIED OR REPRODUCED  
 WITHOUT AUTHORISATION FROM IP ENCLOSURES.  
 www.ipenclosures.com.au

Itemref	Quantity	Title/Name, designation, material, dimension etc	Article No./Reference
IP	1	204x204x104 FILTER FAN	IP-V3200
Designed by	Checked by	Approved by - date	Filename
IP	IP		IP-V3200
			Date
			22/06/22
			Scale
			1:4
Edition			Sheet
0			1/1