

SST TERMINAL BOX

IP-SST161610

316 STAINLESS STEEL | IP66, IP67

160H x 160W x 100D

The IP Enclosures SST Range of grade 316 stainless steel terminal boxes are designed for use even to the most demanding industrial environments.

Protection: IP66, IP67, NEMA 4x

Standard: UL508A Certified 

Material:

- Body: 1.0mm. Grade 316 stainless steel
- Door: 1.0mm. Grade 316 stainless steel
- Seal: Silicone

Body: The robust body is fabricated using 1.0mm Grade 316 Stainless Steel and incorporates a high quality Silicone seal.

Lid/Door: The robust pre-drilled lid/door is fabricated using 1.00mm Grade 316 Stainless Steel and is fastened using screws.

Seal: A high quality Silicone seal.

Internal Plate: The inner plate is fabricated using 2.5mm sheet steel, supplied pre-fitted into the terminal box as standard.

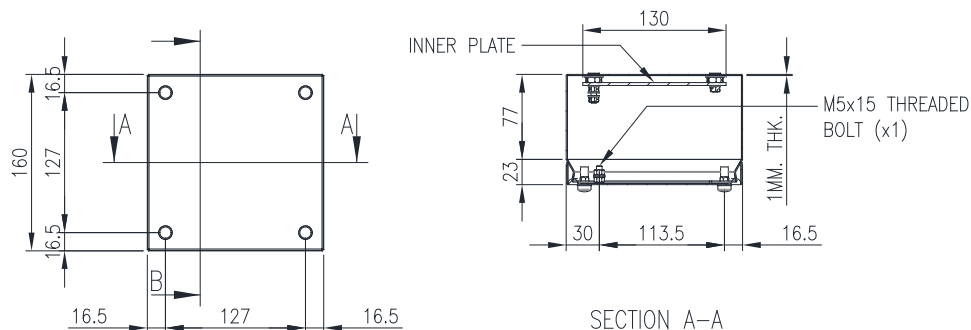

FRONT VIEW

SECTION A-A

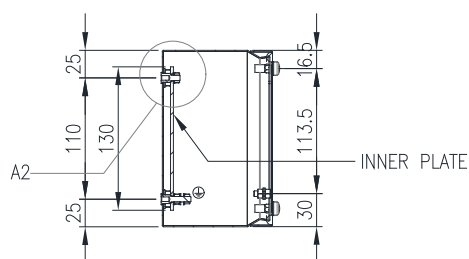

SECTION B-B

