

RevNo	Revision note	Date	Signature	Checked
2	GENERAL REVISION	9/7/19	IP	IP

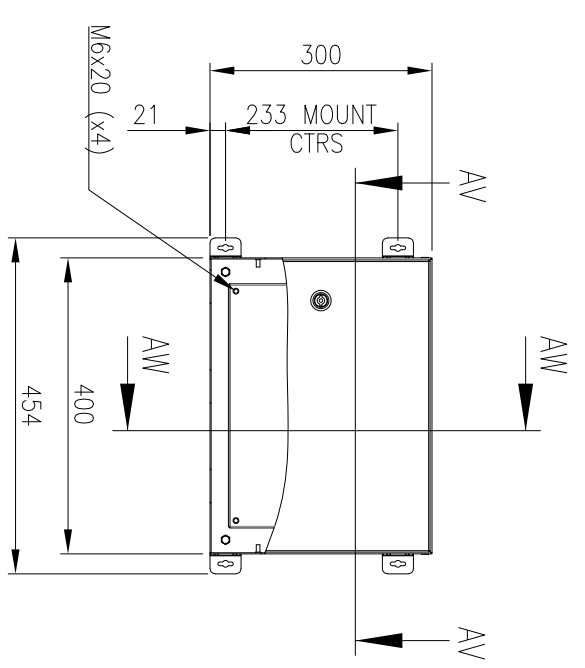

FRONT VIEW

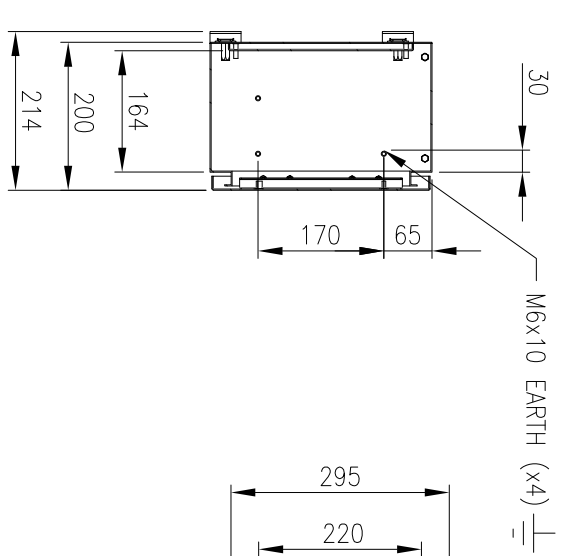

SECTION AW-AW

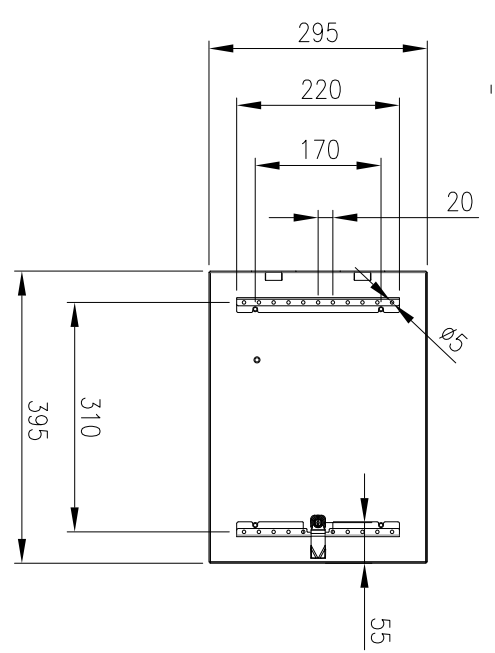

INSIDE DOOR VIEW

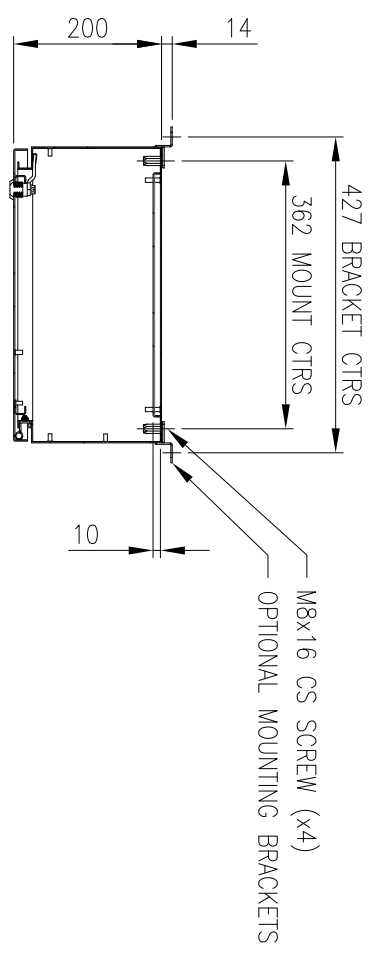
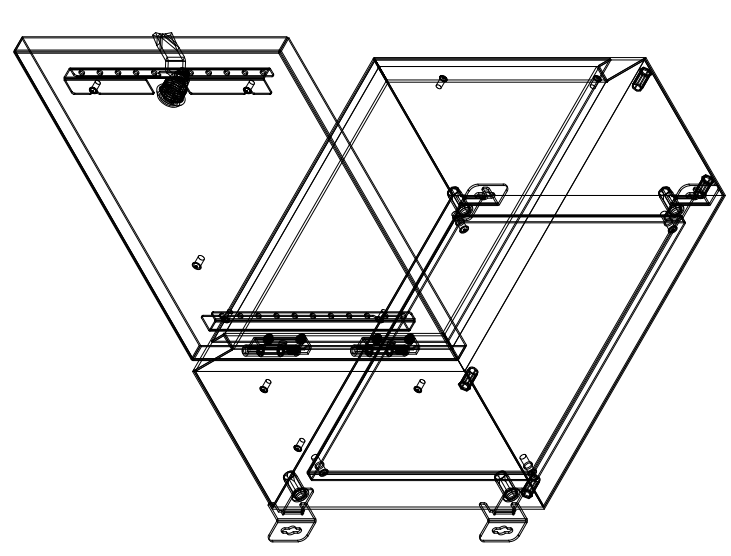

SECTION AV-AV

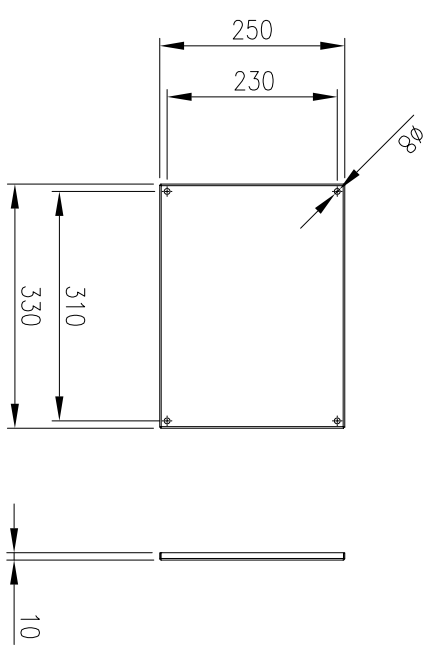

DEVICE MOUNTING PLATE

MATERIAL
 BODY: 1.5mm 316 STAINLESS STEEL
 DOOR: 1.5mm 316 STAINLESS STEEL
 DEVICE PLATE: 1.5mm GALV STEEL
 SEAL: POLYURETHANE
 MASS: 9.0kg

PROTECTION: IP66 IK10, NEMA4x
 STANDARD: IEC62208, IEC/EN/AS60529

© IP ENCLOSURES 2016.
 THIS DRAWING SHALL NOT BE COPIED OR REPRODUCED
 WITHOUT AUTHORISATION FROM IP ENCLOSURES.
 www.ipenclosures.com.au

Item#	Quantity	TradeName, designation, material, dimension etc.	Article No./Reference	Scale
IP				1:10
Designed by	Checked by	Approved by - date	Filename	Date
IP	IP	05/06/17	IP-SS30402-01	05/06/17
			300HH400Wx200D 316SS ENCLOSURE	
			IP-SS304020-01	2
			IP Enclosures	1/1