

RevNo	Revision note	Date	Signature	Checked
2	GENERAL REVISION	28/03/23	IP	IP

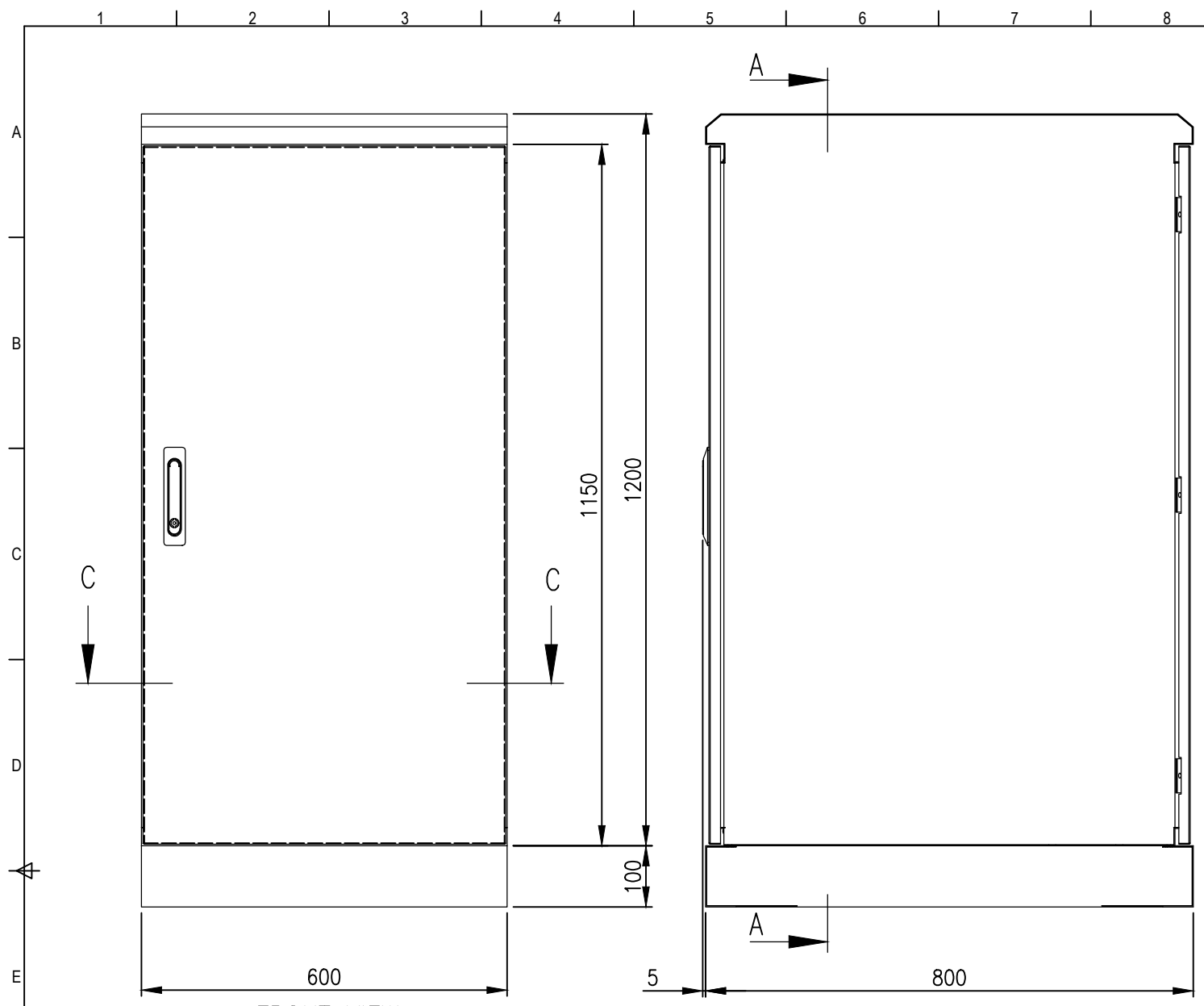

FRONT VIEW

SIDE VIEW

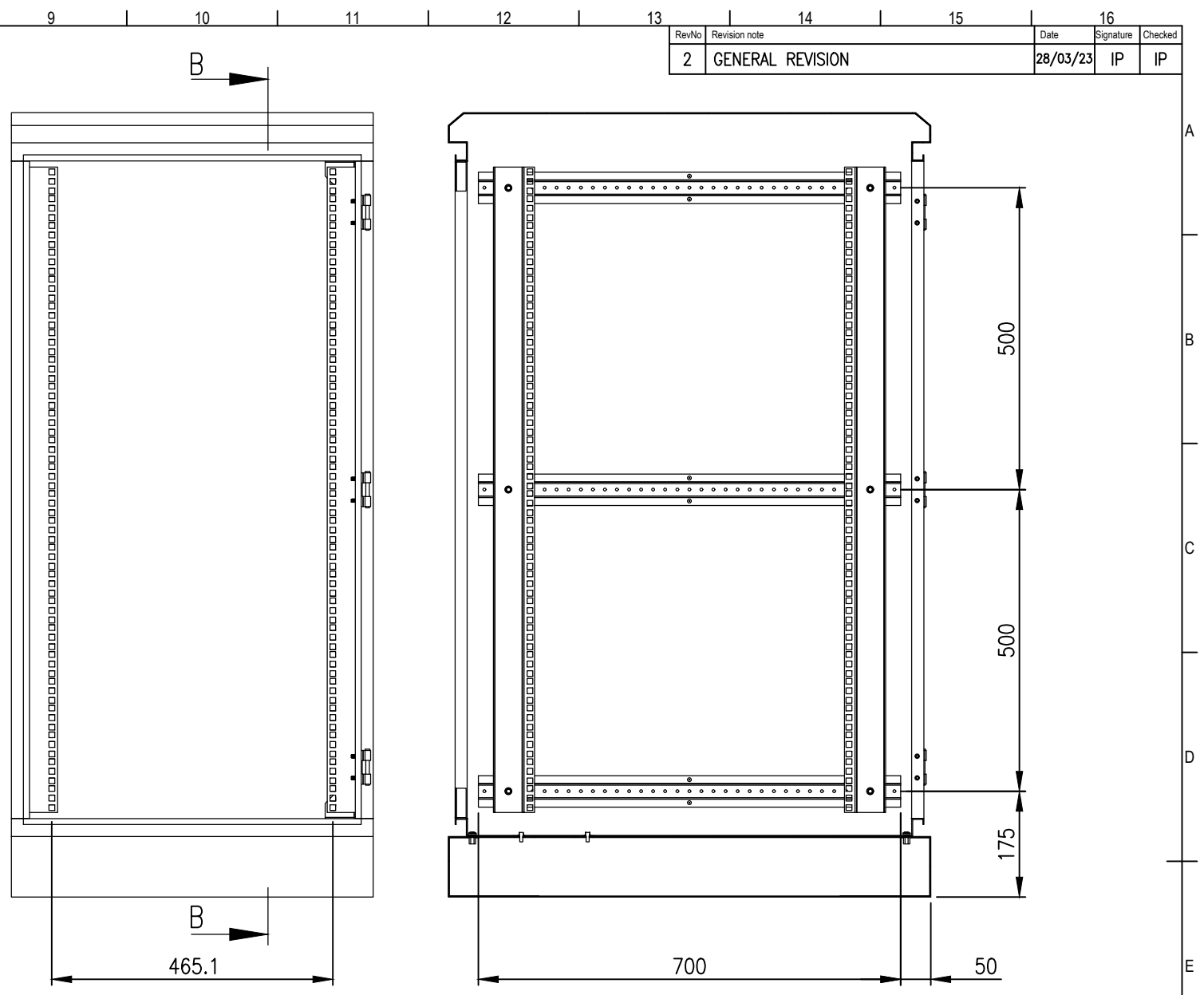

SECTION AA

SECTION BB

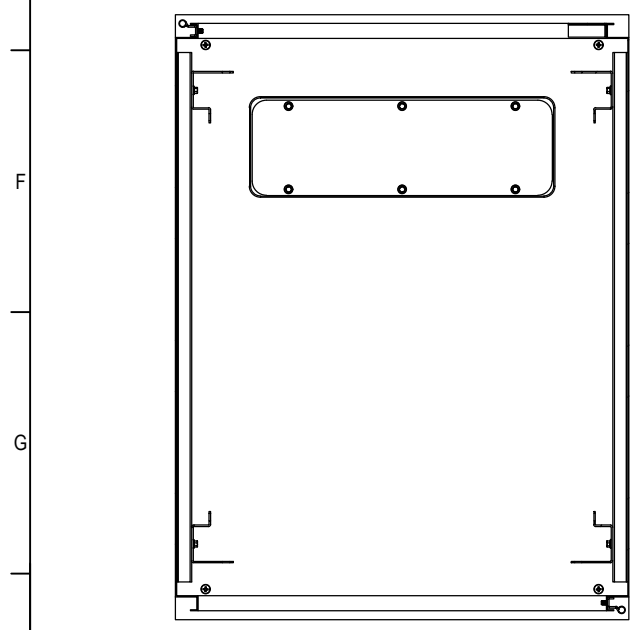

SECTION CC

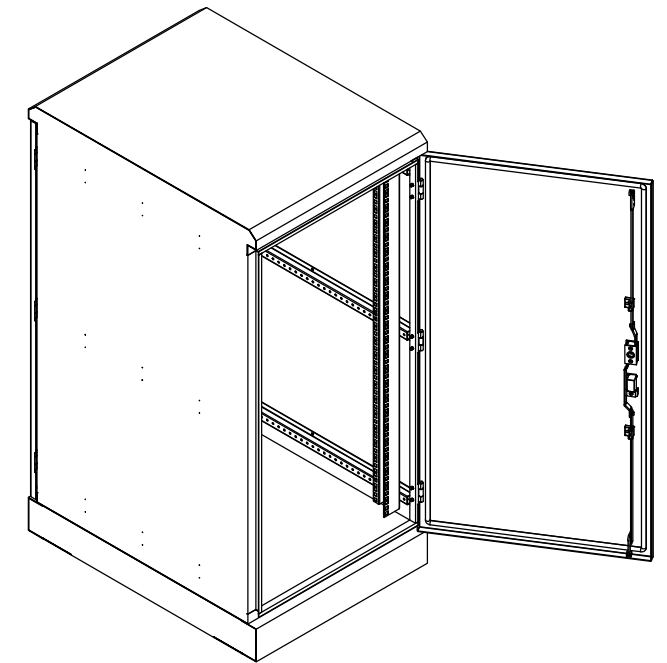

MATERIAL
 BODY: 1.5mm STAINLESS STEEL
 DOOR: 1.5mm STAINLESS STEEL
 19" DATA RACK RAILS: 1.5mm GALVANISED STEEL
 SEAL: POLYURETHANE

PROTECTION: IP66 IK10, NEMA4
STANDARD: IEC/EN/AS60529

© IP ENCLOSURES 2018.
 THIS DRAWING SHALL NOT BE COPIED OR REPRODUCED
 WITHOUT AUTHORISATION FROM IP ENCLOSURES.
 www.ipenclosures.com.au

Itemref	Quantity	Title/Name, designation, material, dimension etc	Article No./Reference
Designed by IP	Checked by IP	Approved by - date 02/07/18	Filename IP-SSD1206080
		Date 02/07/18	Scale 1:10
			24RU 316SS IP66 19" DATA RACK IP-SSD1206080
			Edition 2 Sheet 1/1