

RevNo	Revision note	Date	Signature	Checked
2	GENERAL REVISION	24/03/23	IP	IP

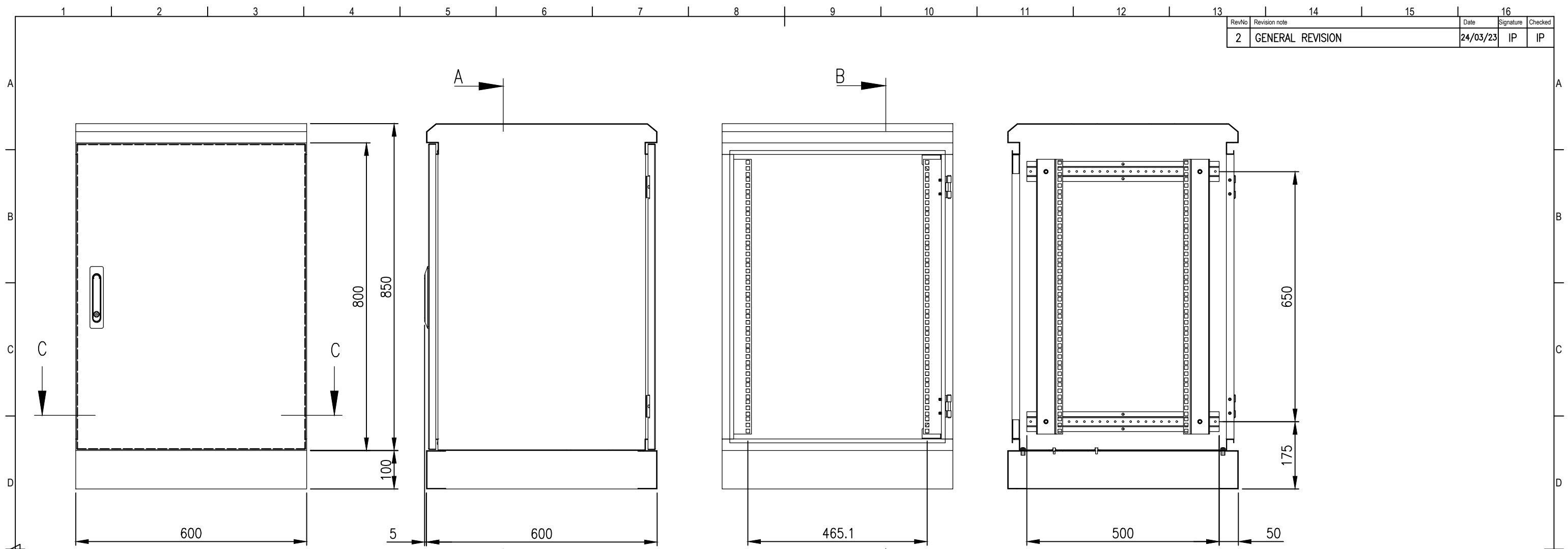

FRONT VIEW

SIDE VIEW

SECTION AA

SECTION BB

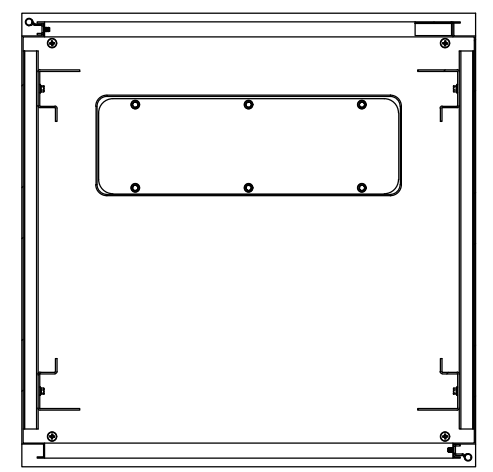

SECTION CC

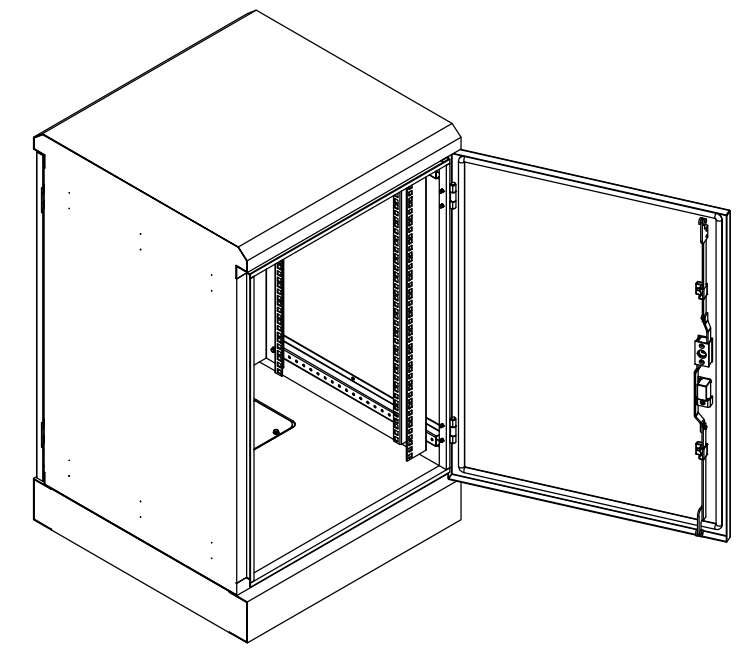

MATERIAL
 BODY: 1.5mm GALVANISED STEEL SHEET
 DOOR: 1.5mm GALVANISED STEEL SHEET
 SEAL: POLYURETHANE
 SURFACE TREATMENT: POWDER-COAT 80-120micron

PROTECTION: IP66 IK10, NEMA4
STANDARD: IEC/EN/AS60529

© IP ENCLOSURES 2018.
 THIS DRAWING SHALL NOT BE COPIED OR REPRODUCED
 WITHOUT AUTHORISATION FROM IP ENCLOSURES.
 www.ipenclosures.com.au

Itemref	Quantity	Title/Name, designation, material, dimension etc	Article No./Reference
Designed by IP	Checked by IP	Approved by - date 02/07/18	Filename IP-SD806060
		Date 02/07/18	Scale 1:10
			16RU 800x600x600 IP66 19" DATA RACK
IP-SD806060			Edition 2
			Sheet 1/1