

RevNo	Revision note	Date	Signature	Checked
2	GENERAL REVISION	24/03/23	IP	IP

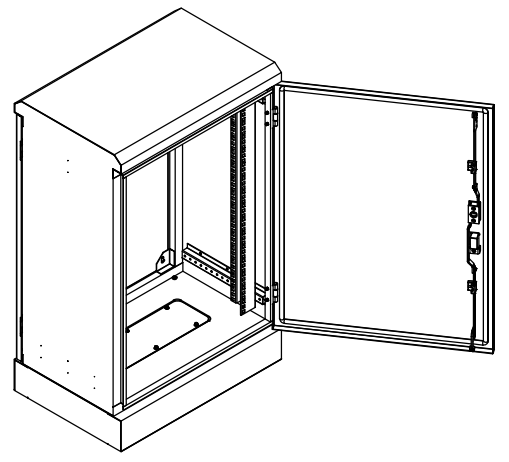
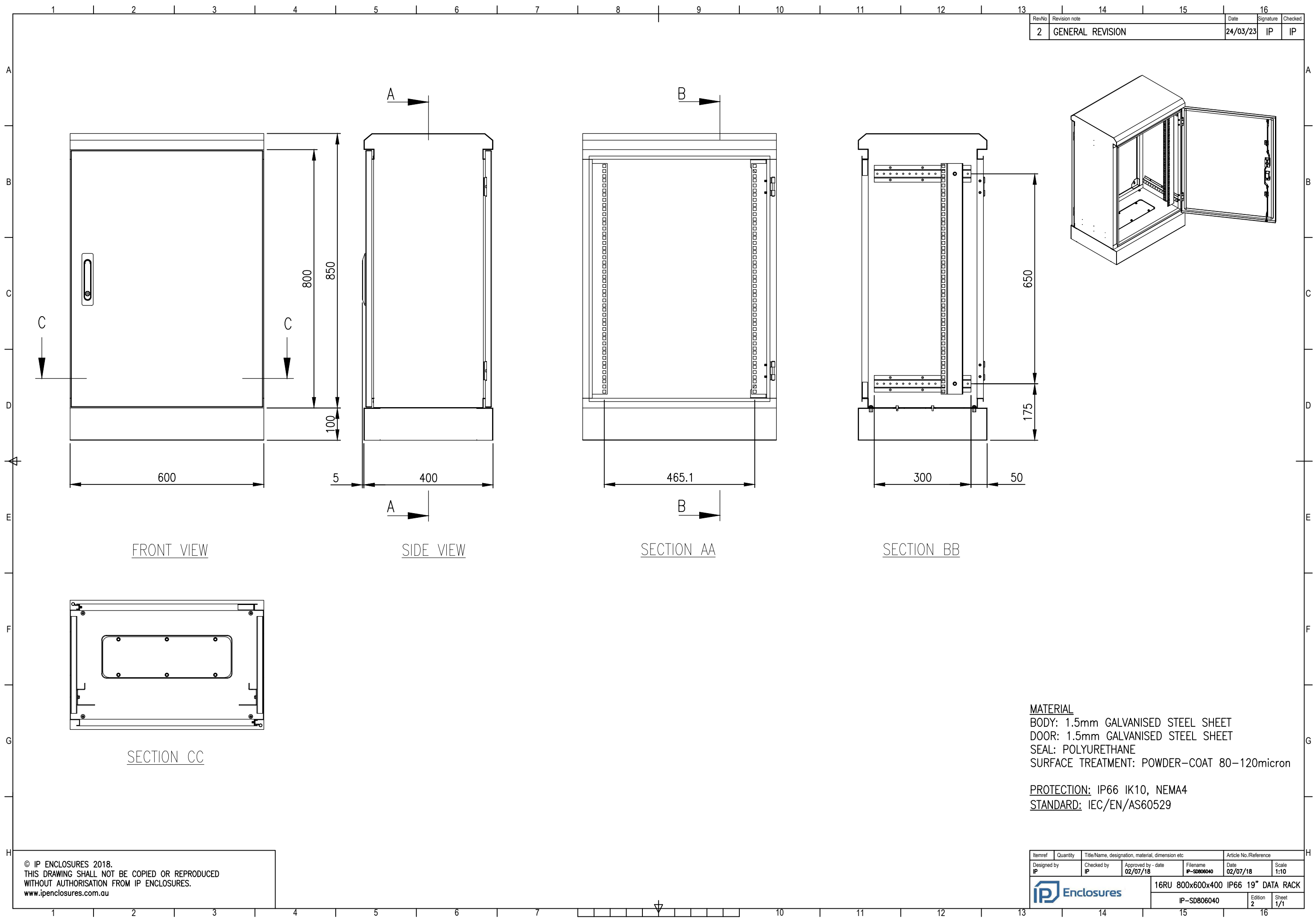

FRONT VIEW

SIDE VIEW

SECTION AA

SECTION BB

SECTION CC

MATERIAL
 BODY: 1.5mm GALVANISED STEEL SHEET
 DOOR: 1.5mm GALVANISED STEEL SHEET
 SEAL: POLYURETHANE
 SURFACE TREATMENT: POWDER-COAT 80-120micron

PROTECTION: IP66 IK10, NEMA4
STANDARD: IEC/EN/AS60529

© IP ENCLOSURES 2018.
 THIS DRAWING SHALL NOT BE COPIED OR REPRODUCED
 WITHOUT AUTHORISATION FROM IP ENCLOSURES.
 www.ipenclosures.com.au

Itemref	Quantity	Title/Name, designation, material, dimension etc		Article No./Reference	
Designed by IP	Checked by IP	Approved by - date 02/07/18	Filename IP-SD806040	Date 02/07/18	Scale 1:10
			16RU 800x600x400 IP66 19" DATA RACK		
			IP-SD806040	Edition 2	Sheet 1/1