

RevNo	Revision note	Date	Signature	Checked
0	GENERAL REVISION		IP	IP

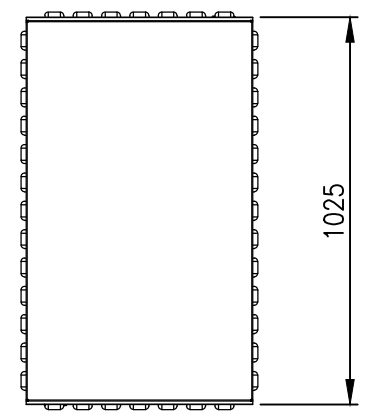

TOP VIEW

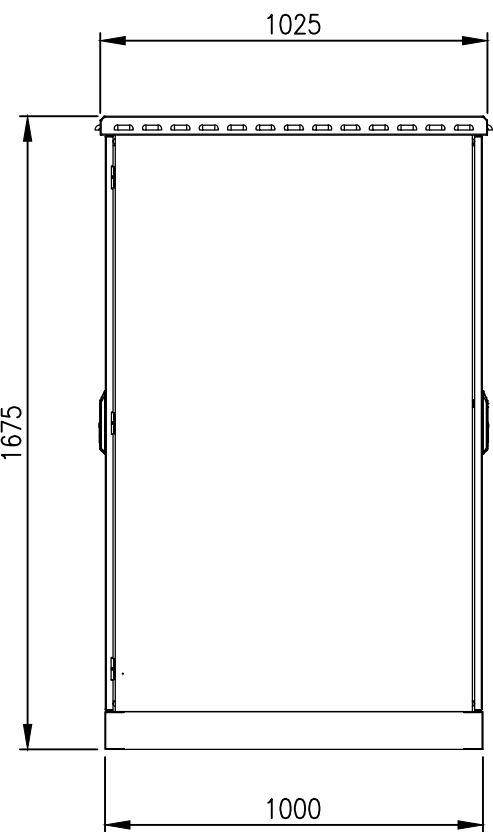

LEFT SIDE VIEW

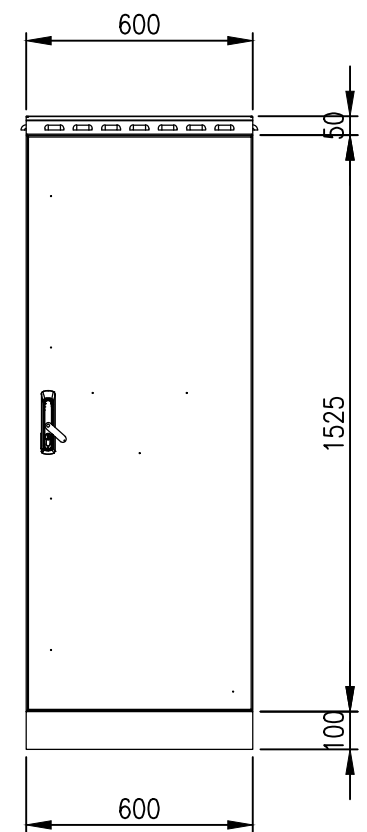

FRONT VIEW

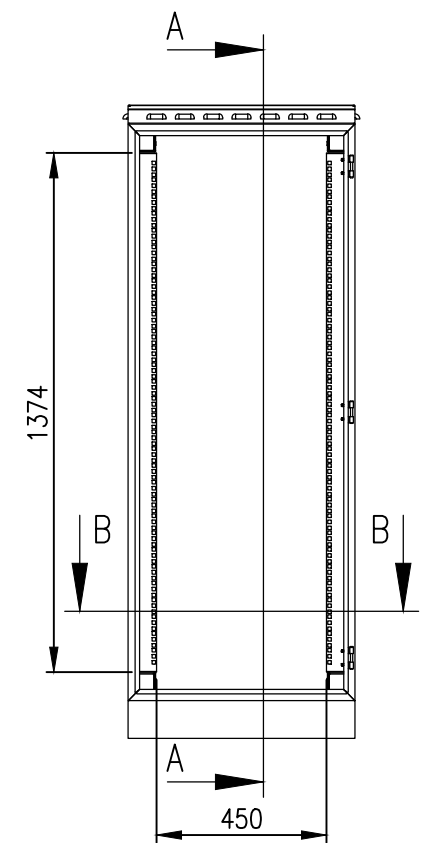

INTERIOR VIEW-DOOR REMOVED

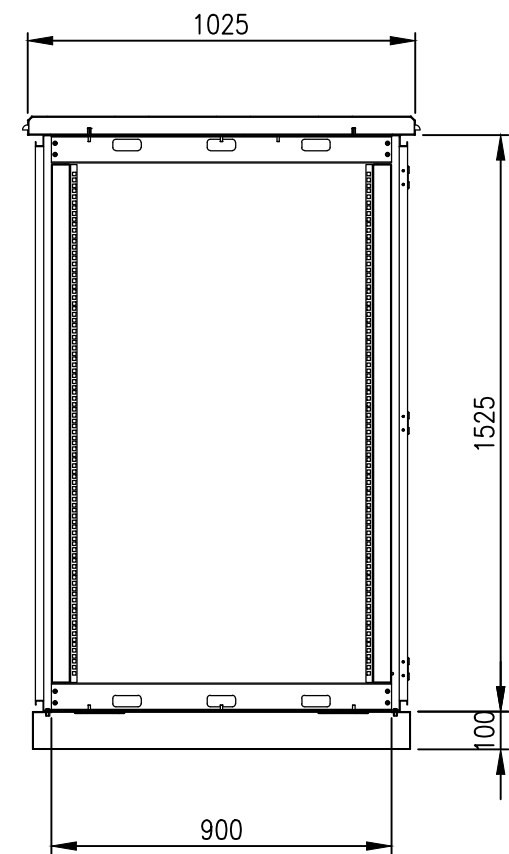

SECTION A-A

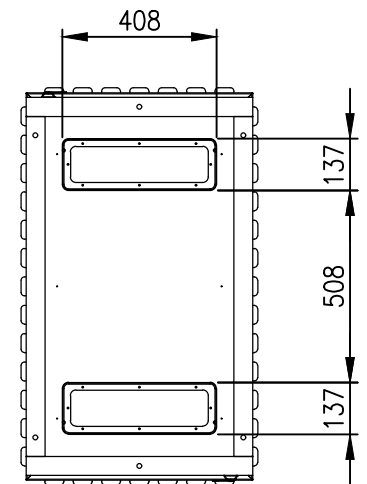
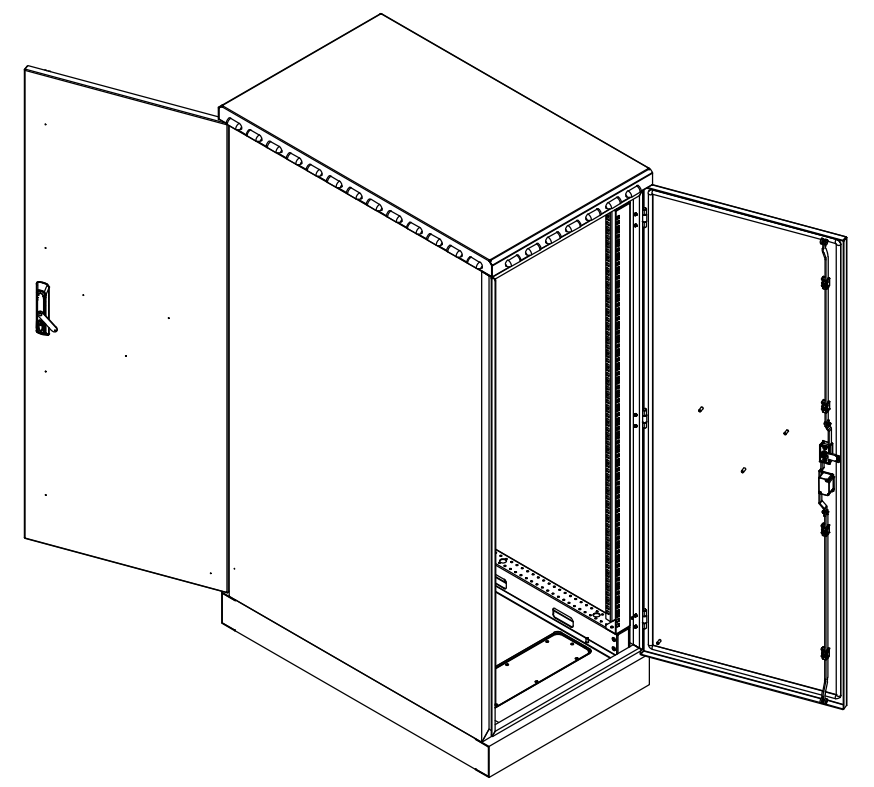

BOTTOM VIEW

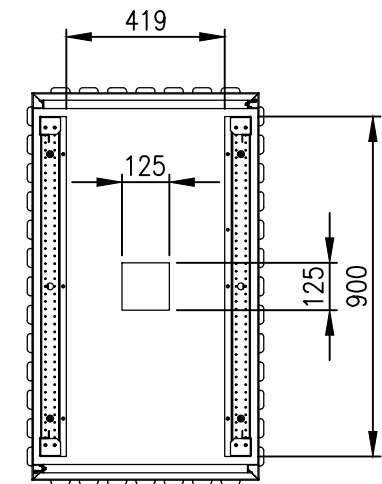

SECTION B-B

MATERIAL
 BODY: 1.5mm GALVANISED STEEL SHEET
 DOORS: 1.5mm GALVANISED STEEL SHEET
 SEAL: POLYURETHANE
 SURFACE TREATMENT: POWDER-COAT 80-120micron

PROTECTION: IP55 IK10, NEMA4
STANDARD: IEC/EN/AS60529

© IP ENCLOSURES 2023.
 THIS DRAWING SHALL NOT BE COPIED OR REPRODUCED
 WITHOUT AUTHORISATION FROM IP ENCLOSURES.
 www.ipenclosures.com.au

Itemref	Quantity	Title/Name, designation, material, dimension etc	Article No./Reference
IP	1	30RU 1670x600x1000 IP55 19" DATA RACK	IP-SD16760100
IP	1	IP-SD16760100	IP-SD16760100