

RevNo	Revision note	Date	Signature	Checked
2	GENERAL REVISION	05/06/25	IP	IP

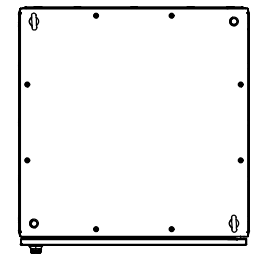

TOP VIEW

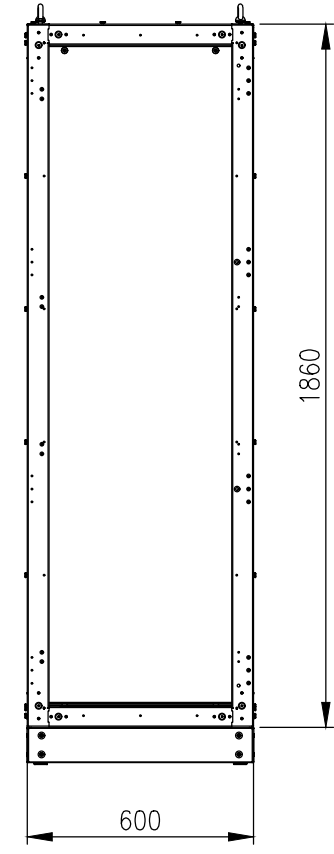

FRONT VIEW  
(PANELS REMOVED)

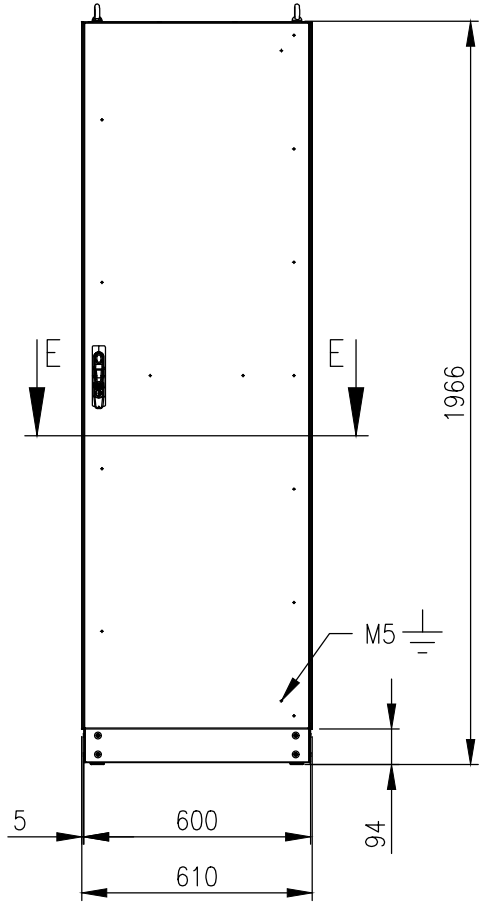

FRONT VIEW  
(ASSEMBLY)

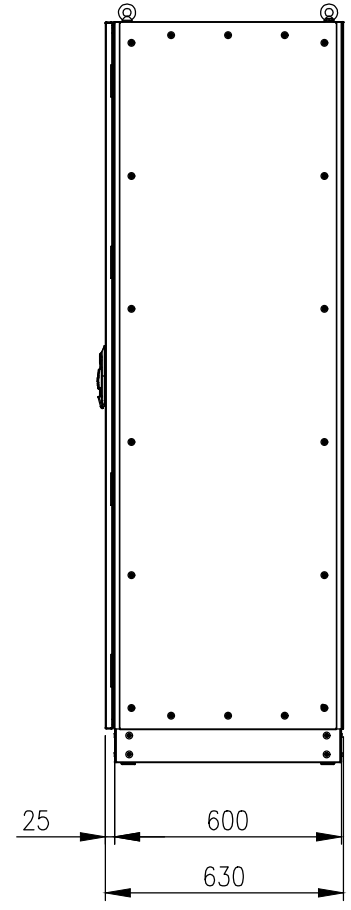

SIDE VIEW

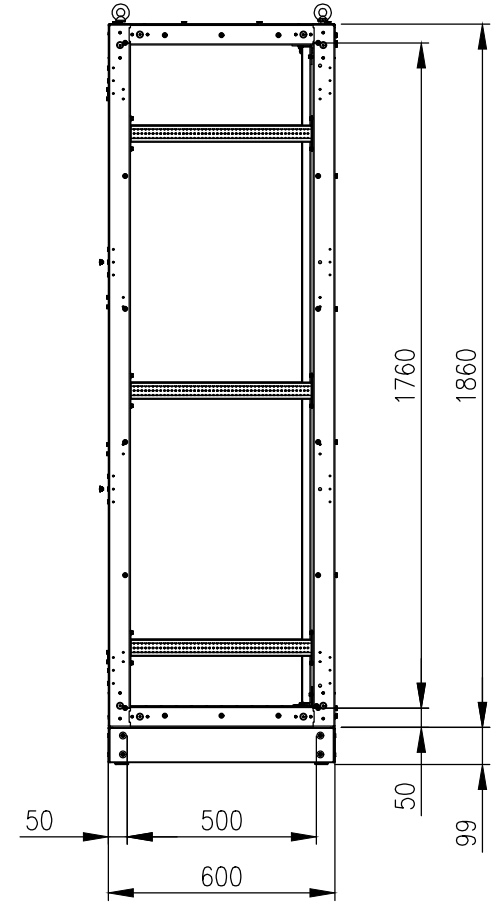

SIDE VIEW  
(PANELS REMOVED)

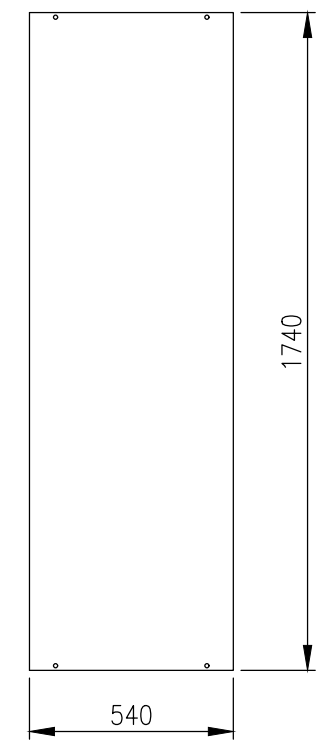

DEVICE MOUNTING PLATE

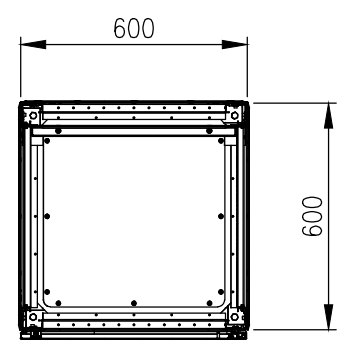
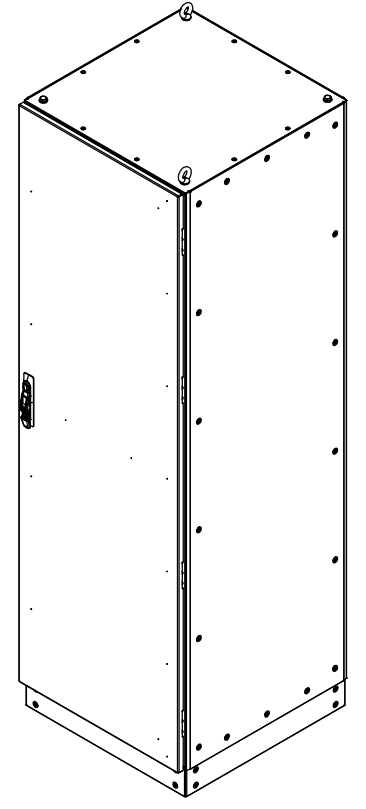

SECTION E-E

**MATERIAL**  
 MAIN FRAME: 2.0mm GRADE 316SS PROFILE  
 PANELS: 1.2mm GRADE 316 STAINLESS STEEL  
 DOOR: 2.0mm GRADE 316 STAINLESS STEEL  
 MOUNTING PLATE: 2.0mm GALVANISED STEEL SHEET  
 SEAL: EPDM

MASS: 130Kg.

PROTECTION: IP55 IK10  
 STANDARD: IEC/EN 62208, IEC/EN/AS60529  
 ORDERING INFORMATION:  
 - ENCLOSURE: IP-MFSS1866060  
 - SIDE PANEL: IP-MFSSP18660  
 - MOUNTING PLATE: IP-MFSSM18660  
 - BASE: IP-MFSSB6060

© IP ENCLOSURES 2017.  
 THIS DRAWING SHALL NOT BE COPIED OR REPRODUCED  
 WITHOUT AUTHORISATION FROM IP ENCLOSURES.  
 www.ipenclosures.com.au

Itemref	Quantity	Title/Name, designation, material, dimension etc	Article No./Reference
Designed by IP	Checked by IP	Approved by - date 22/11/17	Filename IP-MFSS1866060 Date 22/11/17 Scale 1:20
		<b>1860x600x600 316SS FREESTANDING</b> IP-MFSS1866060 Edition 2 Sheet 1/1	