

RevNo	Revision note	Date	Signature	Checked
1	GENERAL REVISION	9/7/19	IP	IP

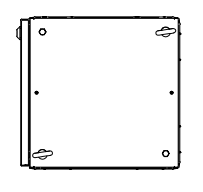

TOP VIEW

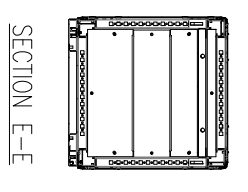
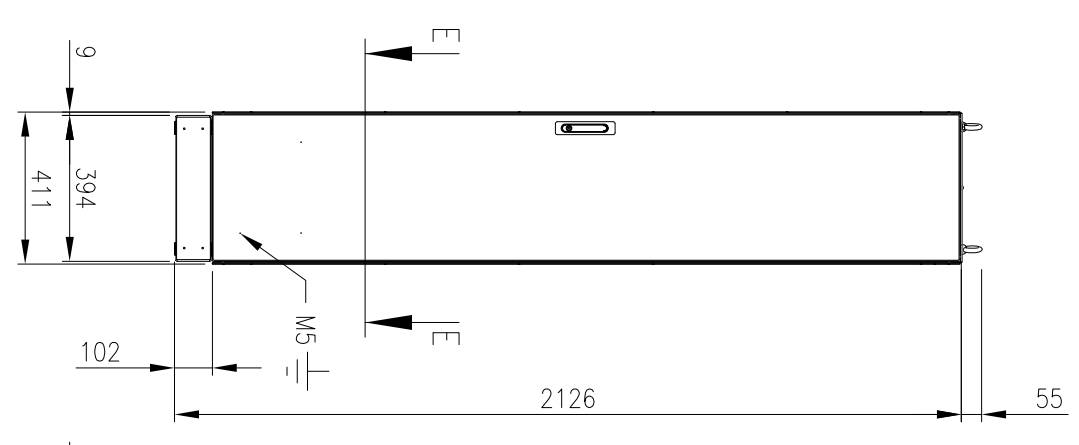

FRONT VIEW
(ASSEMBLY)

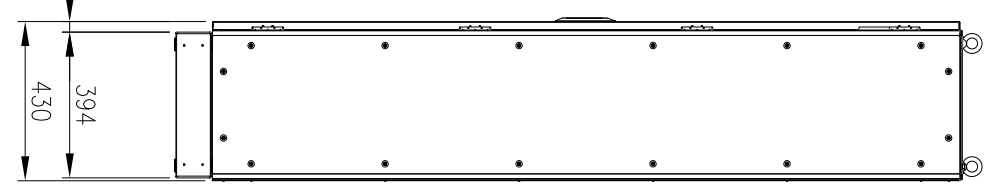

SIDE VIEW

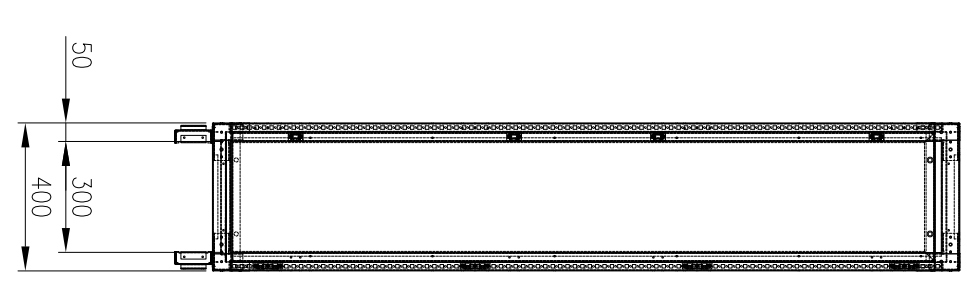

FRONT VIEW
(PANELS REMOVED)

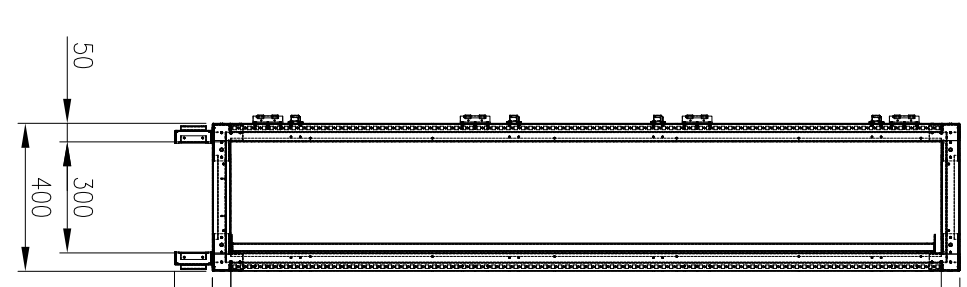

SIDE VIEW
(PANELS REMOVED)

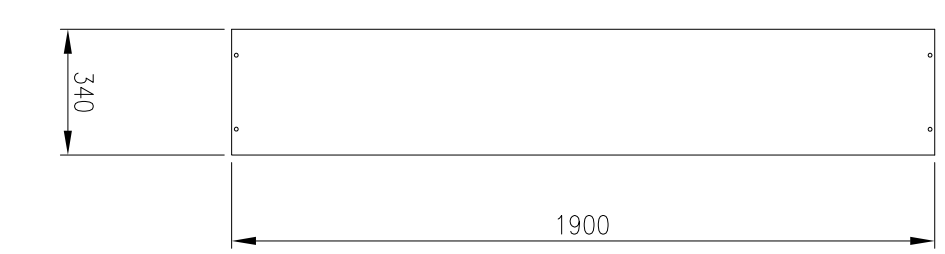
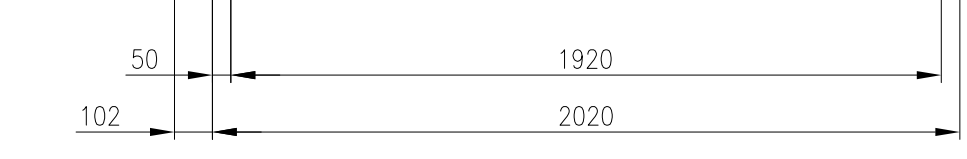

DEVICE MOUNTING PLATE

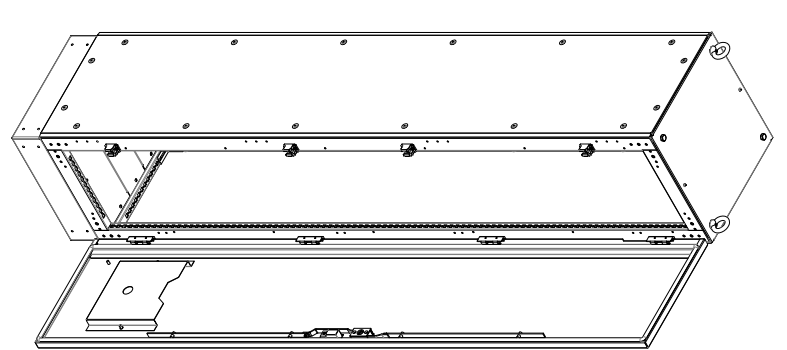

MATERIAL
 MAIN FRAME: 2.0mm GALVANISED STEEL PROFILE
 PANELS: 1.2mm POWDERCOATED GALVANISED SHEET
 DOOR: 2.0mm POWDERCOATED GALVANISED STEEL
 MOUNTING PLATE: 2.0mm GALVANISED STEEL SHEET
 SEAL: EPDM
 SURFACE TREATMENT: POWDER-COAT 80-120micron
 STANDARD COLOUR: RAL7035

PROTECTION: IP55 IK10
 STANDARD: IEC62208, IEC/EN/AS60529

ORDERING INFORMATION:
 - ENCLOSURE: IP-MFS2024040
 - SIDE PANEL: IP-MFSP20240
 - MOUNTING PLATE: IP-MFSM20240
 - BASE: IP-MFSB4040

© IP ENCLOSURES 2017.
 THIS DRAWING SHALL NOT BE COPIED OR REPRODUCED
 WITHOUT AUTHORISATION FROM IP ENCLOSURES.
 www.ipenclosures.com.au

Item#	Quantity	PartName, designation, material, dimension etc.	Article No./Reference	Scale
IP		Designed by	22/11/17	1:20
IP		Checked by	22/11/17	1/1
		Approved by - date	22/11/17	
		Filename	2020x400x400 STEEL FREESTANDING	
		Date	22/11/17	
		Article No./Reference	IP-MFS2024040	
		Edition	1	
		Sheet	1/1	