

RevNo	Revision note	Date	Signature	Checked
1	GENERAL REVISION	9/7/19	IP	IP

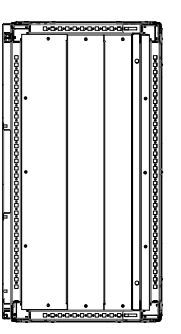

SECTION E-E

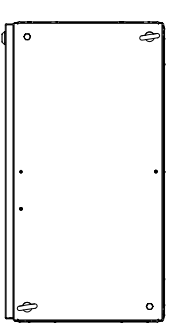

TOP VIEW

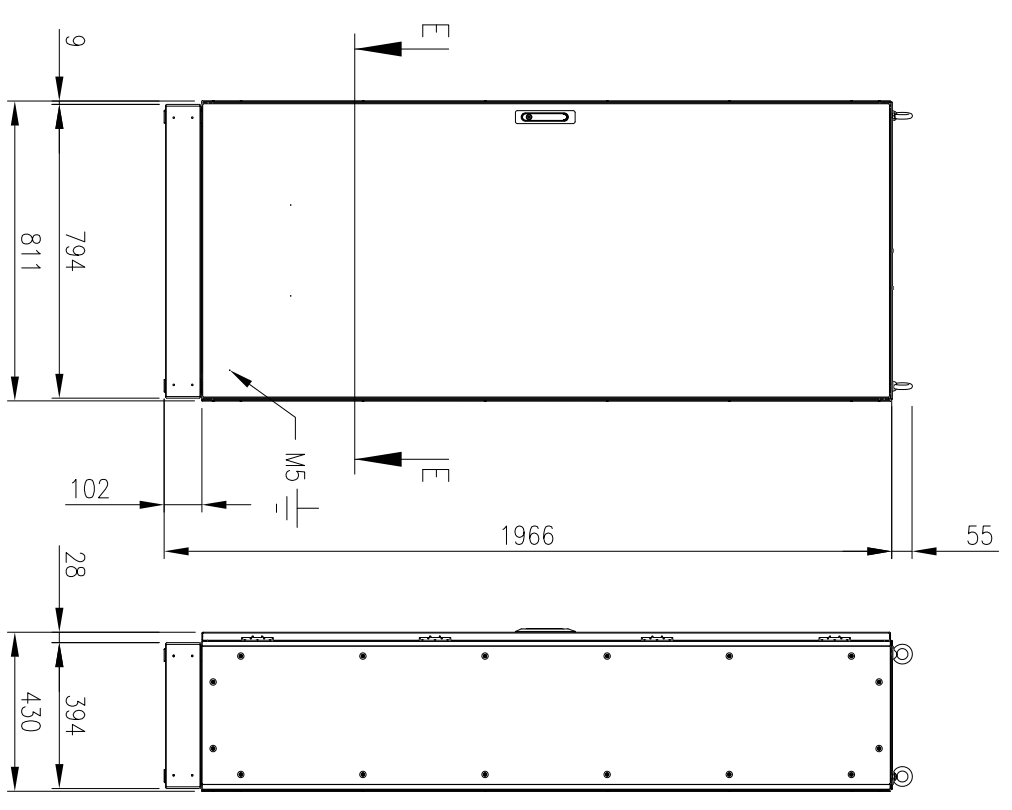

FRONT VIEW  
(ASSEMBLY)

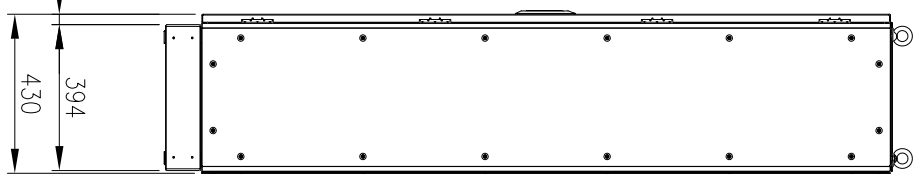

SIDE VIEW

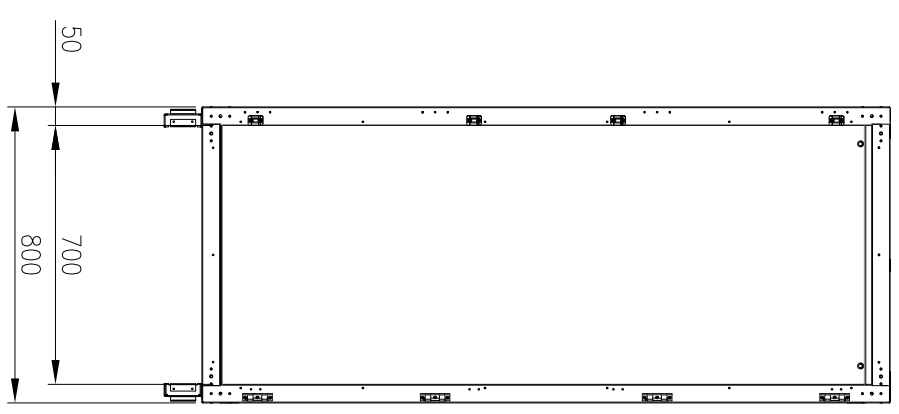

FRONT VIEW  
(PANELS REMOVED)

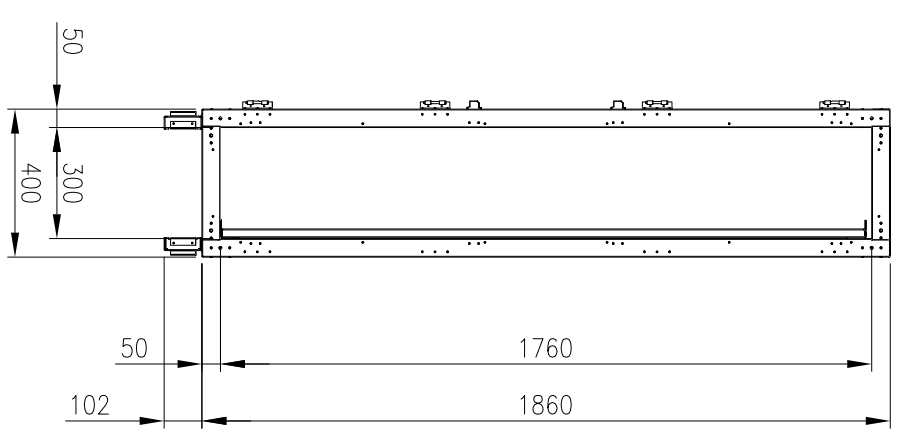

SIDE VIEW  
(PANELS REMOVED)



DEVICE MOUNTING PLATE

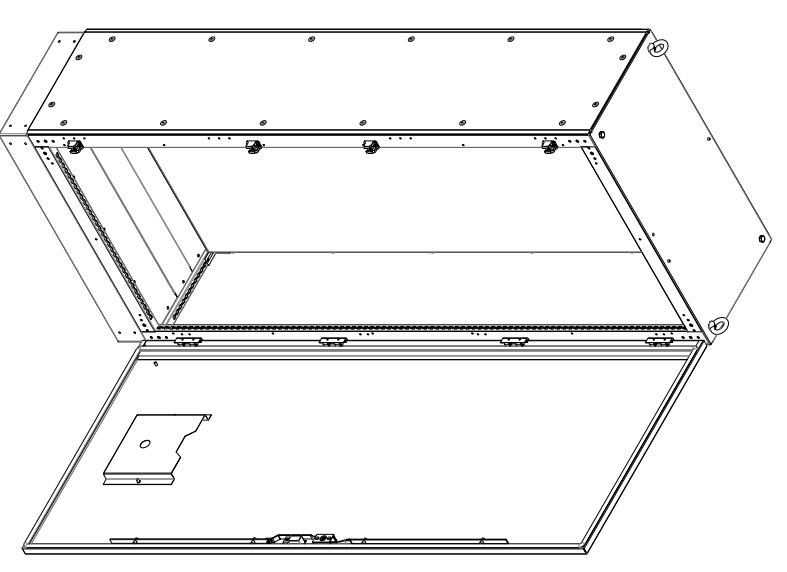

**MATERIAL**  
 MAIN FRAME: 2.0mm GALVANISED STEEL PROFILE  
 PANELS: 1.2mm POWDERCOATED GALVANISED SHEET  
 DOOR: 2.0mm POWDERCOATED GALVANISED STEEL  
 MOUNTING PLATE: 2.0mm GALVANISED STEEL SHEET  
 SEAL: EPDM  
 SURFACE TREATMENT: POWDER-COAT 80-120micron  
 STANDARD COLOUR: RAL7035

PROTECTION: IP55 IK10  
 STANDARD: IEC62208, IEC/EN/AS60529

ORDERING INFORMATION:  
 - ENCLOSURE: IP-MFS1868040  
 - SIDE PANEL: IP-MFSP18640  
 - MOUNTING PLATE: IP-MFSM18680  
 - BASE: IP-MFSB8040

© IP ENCLOSURES 2017.  
 THIS DRAWING SHALL NOT BE COPIED OR REPRODUCED  
 WITHOUT AUTHORISATION FROM IP ENCLOSURES.  
 www.ipenclosures.com.au

Item#	Quantity	PartName, designation, material, dimension etc.	Article No./Reference	Scale
IP		Designed by		1:20
IP		Checked by		1/1
		Approved by - date		
		22/11/17		
		Filename		
		1860x800x400 STEEL FREESTANDING		
		IP-MFS1868040		
		Edition		
		1		
		Sheet		
		1/1		