

RevNo	Revision note	Date	Signature	Checked
3	GENERAL REVISION	29/10/24	IP	IP

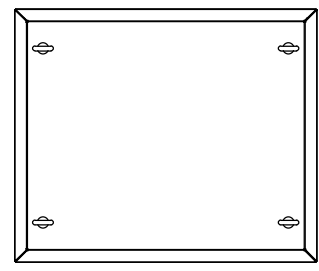

TOP VIEW

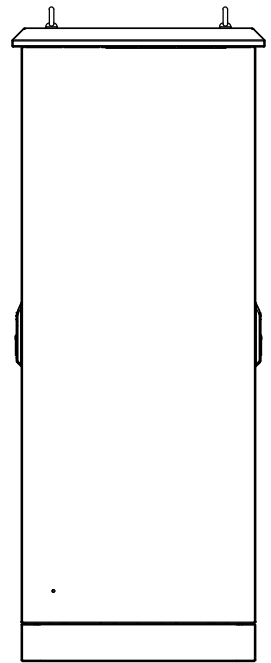

LEFT SIDE VIEW

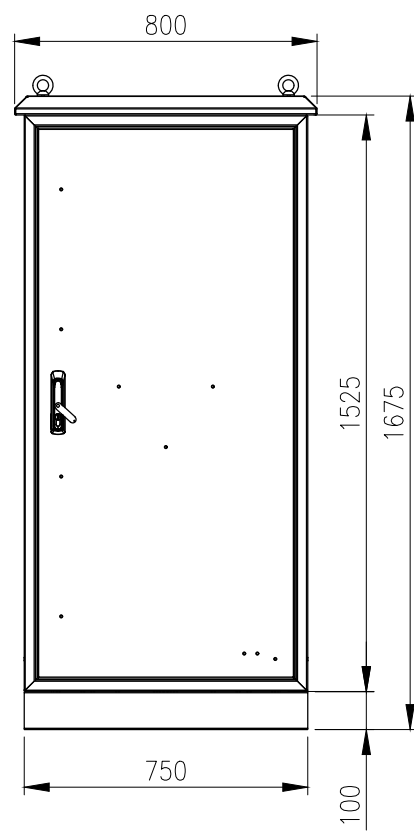

FRONT VIEW (ASSEMBLY)

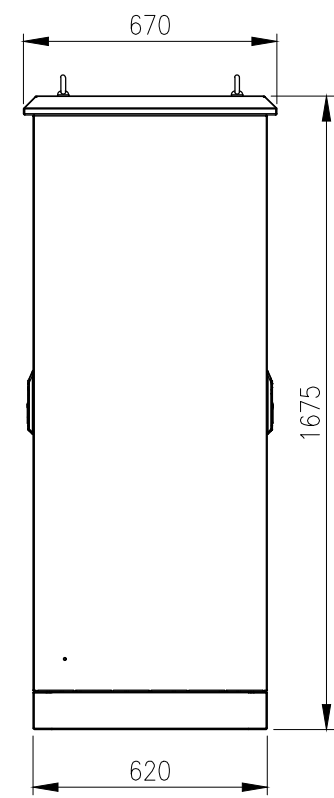

RIGHT SIDE VIEW

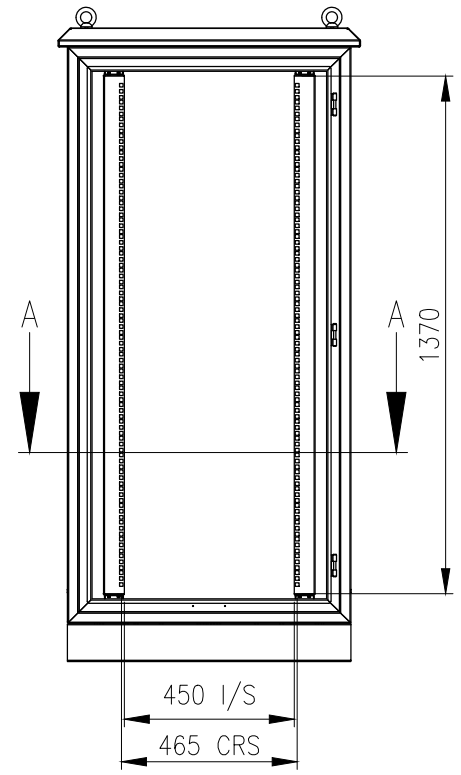

FRONT VIEW (FRONT DOOR REMOVED)

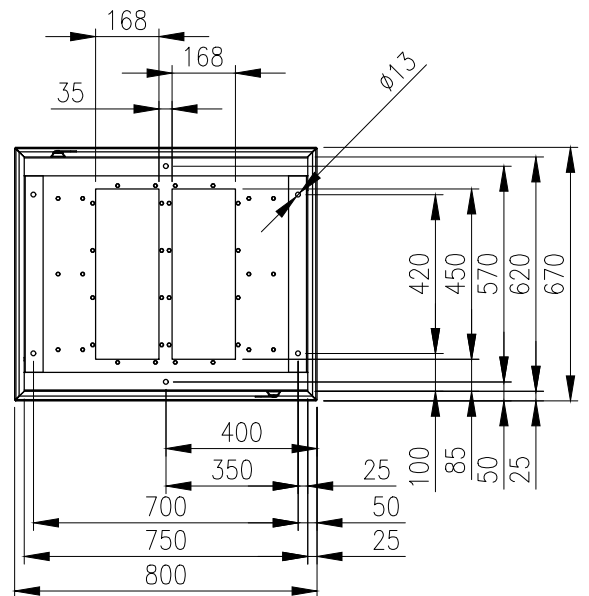
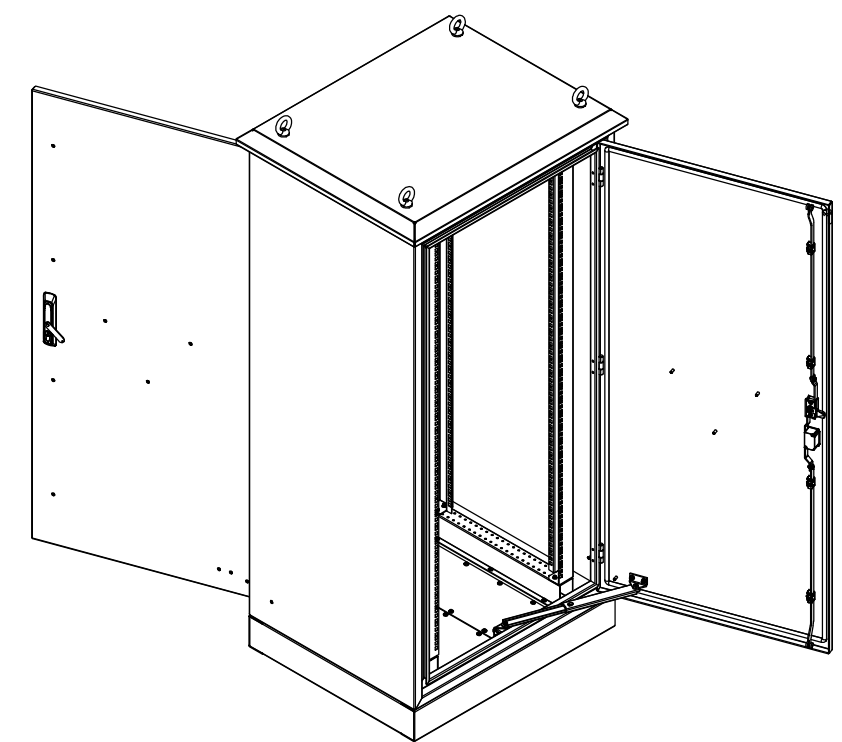

BOTTOM VIEW

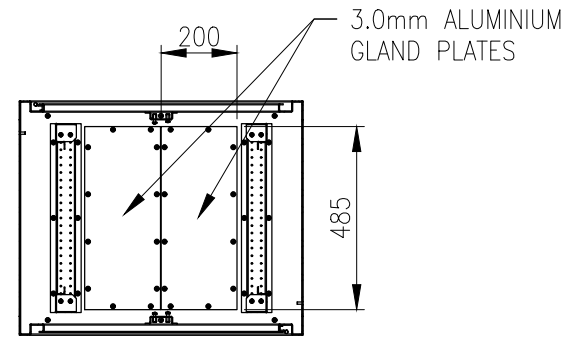

SECTION A-A

MATERIAL
 BODY AND PLINTH: 2.5mm MARINE GRADE ALUMINIUM
 DOORS: 2.5mm MARINE GRADE ALUMINIUM
 19" DATA RAILS: 1.5mm GALVANISED STEEL SHEET
 GLAND PLATE: 3.0mm ALUMINIUM
 SEAL: POLYURETHANE
 SURFACE TREATMENT: POWDER-COAT 80-120micron
 COLOUR: RAL7035 GREY, SMOOTH FINISH

PROTECTION: IP66 IK10
 STANDARD: IEC/EN62208, IEC/EN/AS60529, EIA-310D

© IP ENCLOSURES 2017.
 THIS DRAWING SHALL NOT BE COPIED OR REPRODUCED
 WITHOUT AUTHORISATION FROM IP ENCLOSURES.
 www.ipenclosures.com.au

Itemref	Quantity	Title/Name, designation, material, dimension etc	Article No./Reference
Designed by IP	Checked by IP	Approved by - date 05/08/19	Filename IP-A1677562-0
		Date 05/08/19	Scale 1:20
			30RU ALUMINIUM 1675x750x620 NO VENTS IP-A1677562-0
		Edition 3	Sheet 1/1