

RevNo	Revision note	Date	Signature	Checked
1	GENERAL REVISION	10/06/26	IP	IP

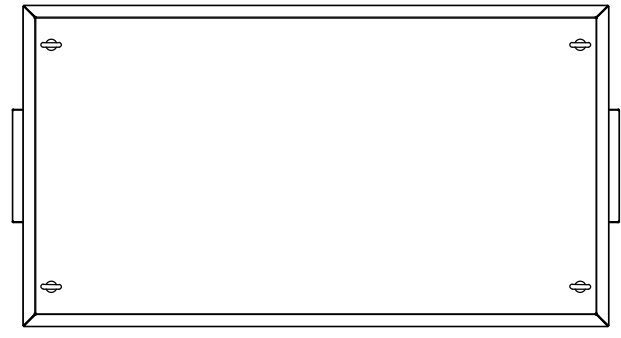

TOP VIEW

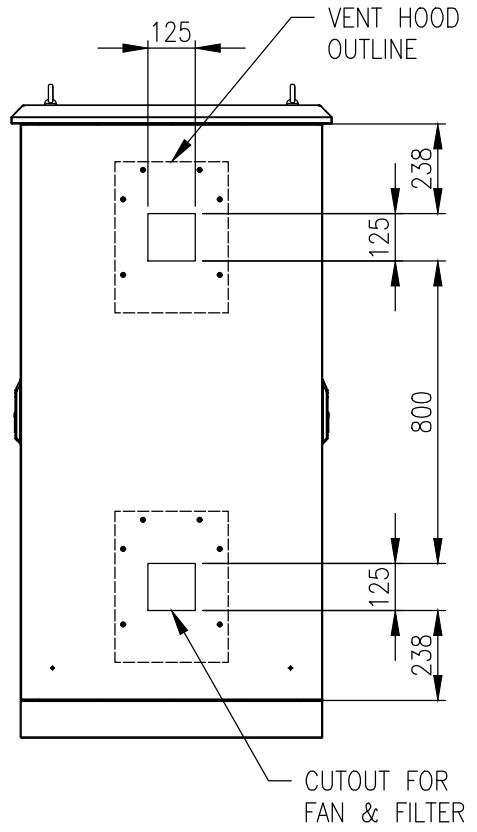
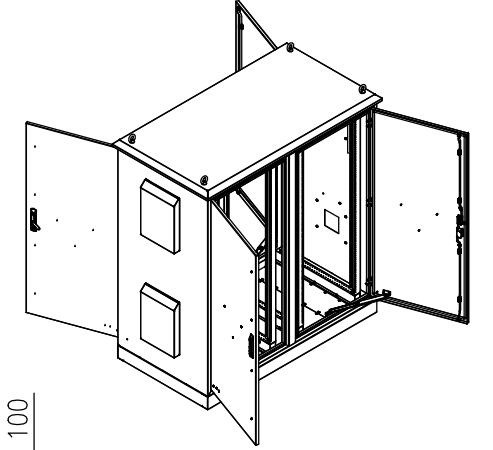

LEFT SIDE VIEW

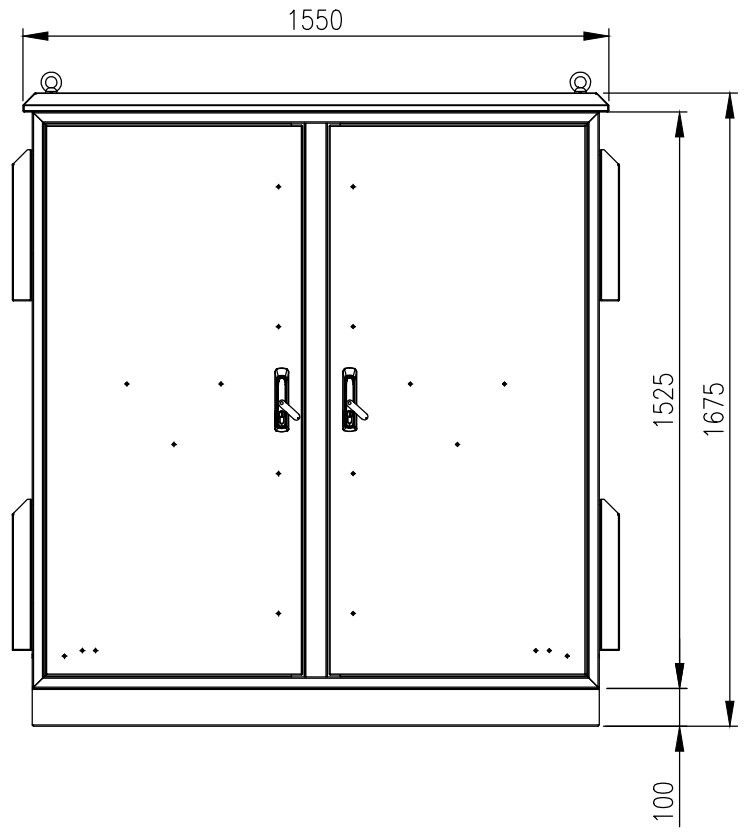

FRONT VIEW

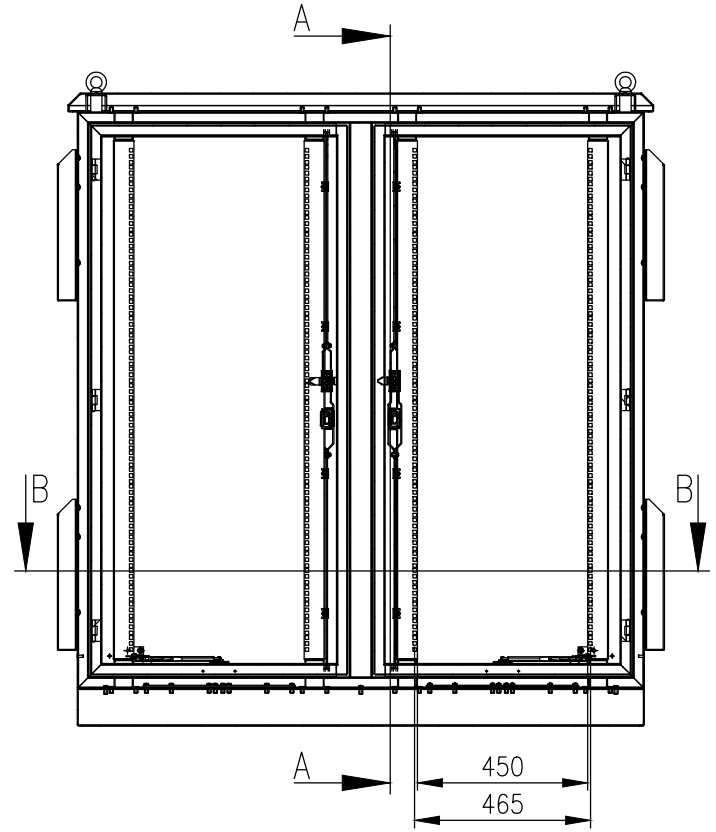

INTERIOR VIEW-DOOR REMOVED

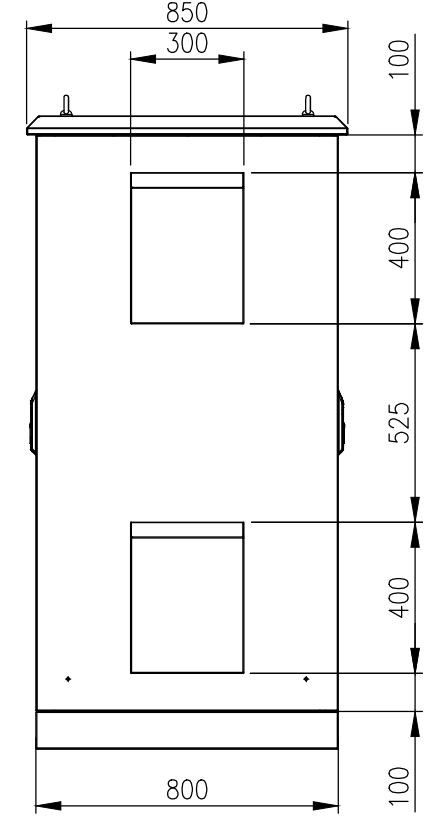

RIGHT SIDE VIEW

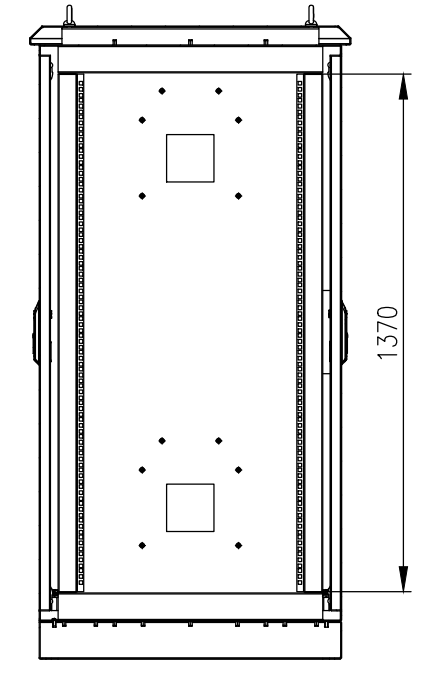

SECTION A-A

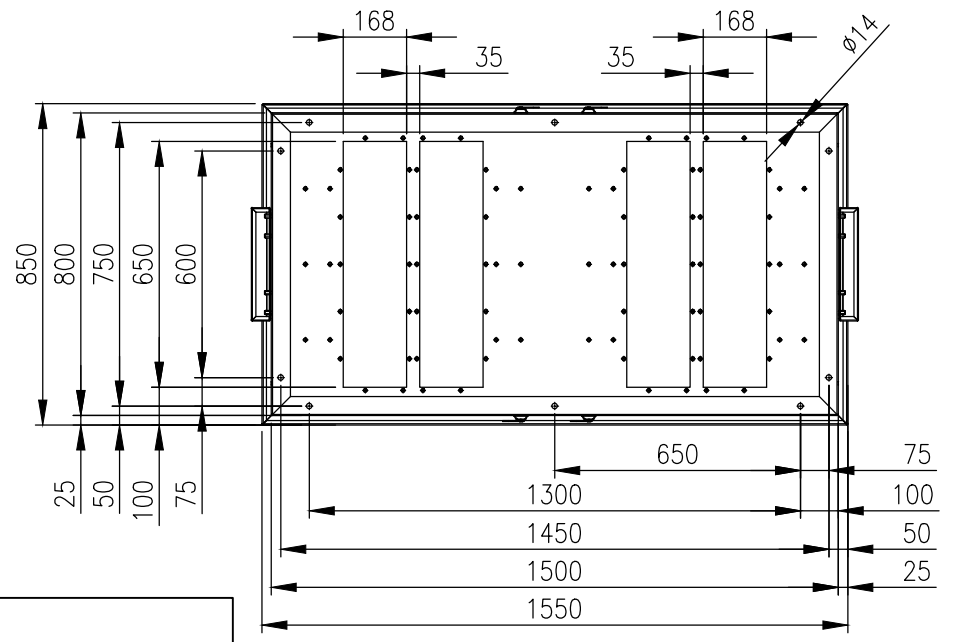

BOTTOM VIEW

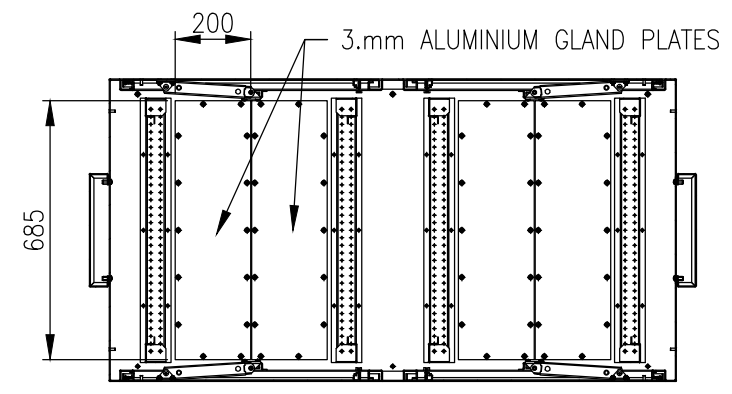

SECTION B-B

MATERIAL
 BODY AND PLINTH: 2.5mm MARINE GRADE ALUMINIUM
 DOORS: 2.5mm MARINE GRADE ALUMINIUM
 19" DATA RAILS: 1.5mm GALVANISED STEEL SHEET
 GLAND PLATE: 3.0mm ALUMINIUM
 SEAL: POLYURETHANE
 SURFACE TREATMENT: POWDER-COAT 80-120micron
 COLOUR: RAL7035 GREY, SMOOTH FINISH

PROTECTION: IP55 IK10 (EXCLUDING FAN/
 FILTER CUTOUTS)
 STANDARD: IEC/EN62208, IEC/EN/AS60529, EIA-310D

© IP ENCLOSURES 2024.
 THIS DRAWING SHALL NOT BE COPIED OR REPRODUCED
 WITHOUT AUTHORISATION FROM IP ENCLOSURES.
 www.ipenclosures.com.au

Itemref	Quantity	Title/Name, designation, material, dimension etc	Article No./Reference
Designed by IP	Checked by IP	Approved by - date 01/02/24	Filename IP-A16715080
		Date 01/02/24	Scale 1:20
			2 x 30RU (60RU) ALUMINIUM FIELD CABINET 1675x1500x600 DOUBLE BAY IP-A16715080
Edition 1			Sheet 1/1