

RevNo	Revision note	Date	Signature	Checked
2	GENERAL REVISION	30/10/24	IP	IP

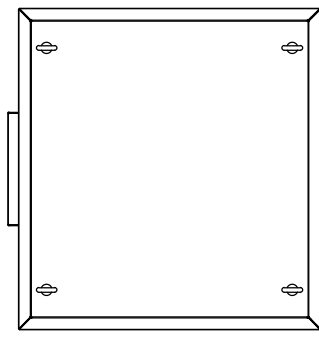

TOP VIEW

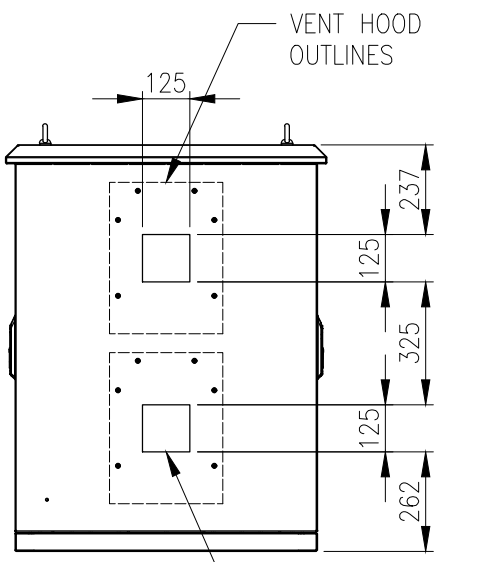

LEFT SIDE VIEW

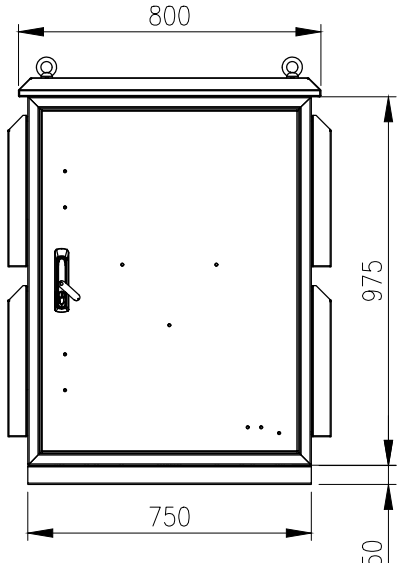

FRONT VIEW (ASSEMBLY)

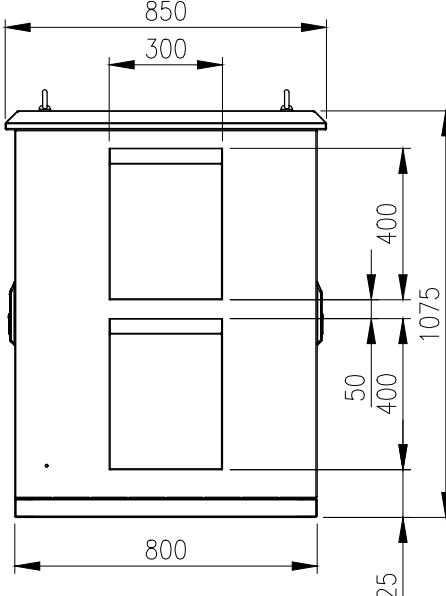

RIGHT SIDE VIEW

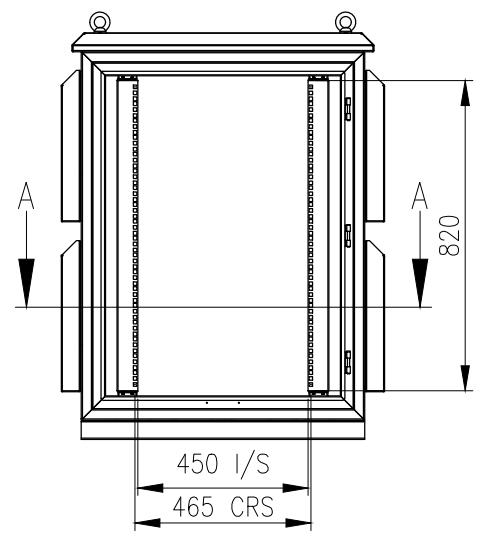

FRONT VIEW (FRONT DOOR REMOVED)

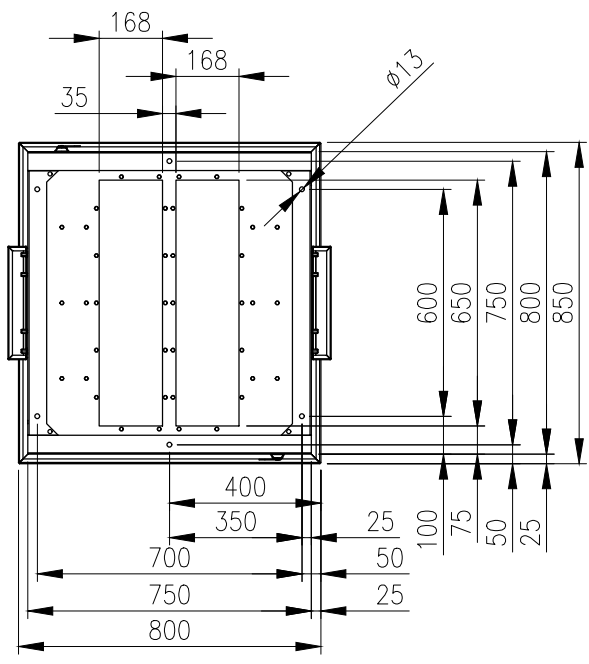
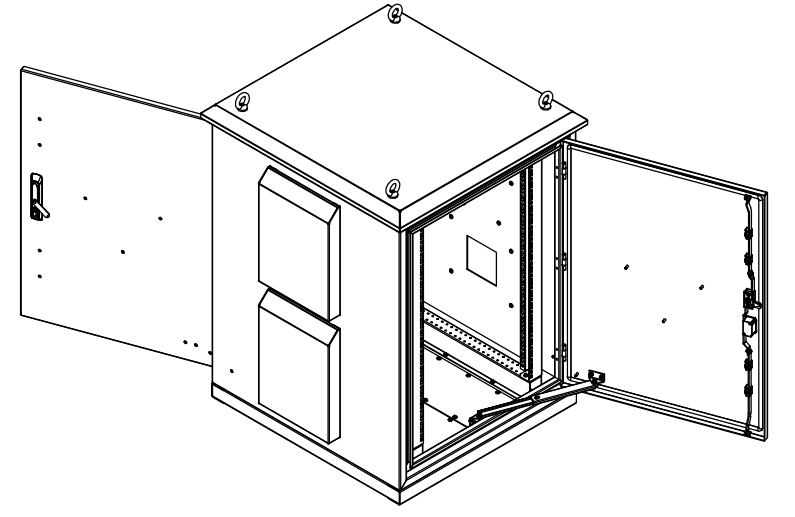

BOTTOM VIEW

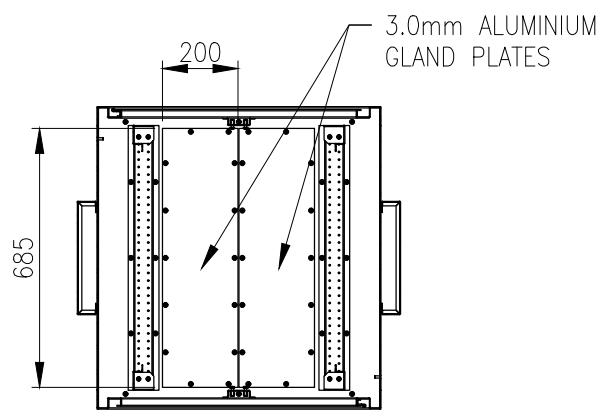

SECTION A-A

**MATERIAL**  
 BODY AND PLINTH: 2.5mm MARINE GRADE ALUMINIUM  
 DOORS: 2.5mm MARINE GRADE ALUMINIUM  
 19" DATA RAILS: 1.5mm GALVANISED STEEL SHEET  
 GLAND PLATE: 3.0mm ALUMINIUM  
 SEAL: POLYURETHANE  
 SURFACE TREATMENT: POWDER-COAT 80-120micron  
 COLOUR: RAL7035 GREY, SMOOTH FINISH

PROTECTION: IP55 IK10 (EXCLUDING FAN/  
 FILTER CUTOUTS)  
 STANDARD: IEC/EN62208, IEC/EN/AS60529, EIA-310D

© IP ENCLOSURES 2017.  
 THIS DRAWING SHALL NOT BE COPIED OR REPRODUCED  
 WITHOUT AUTHORISATION FROM IP ENCLOSURES.  
 www.ipenclosures.com.au

Itemref	Quantity	Title/Name, designation, material, dimension etc	Article No./Reference
Designed by IP	Checked by IP	Approved by - date 05/08/19	Filename IP-A1077580
		Date 05/08/19	Scale 1:20
			18RU CABINET ALUMINIUM 1075x750x800
IP-A1077580			Edition 2
			Sheet 1/1