

RevNo	Revision note	Date	Signature	Checked
1	GENERAL REVISION	31/01/25	IP	IP

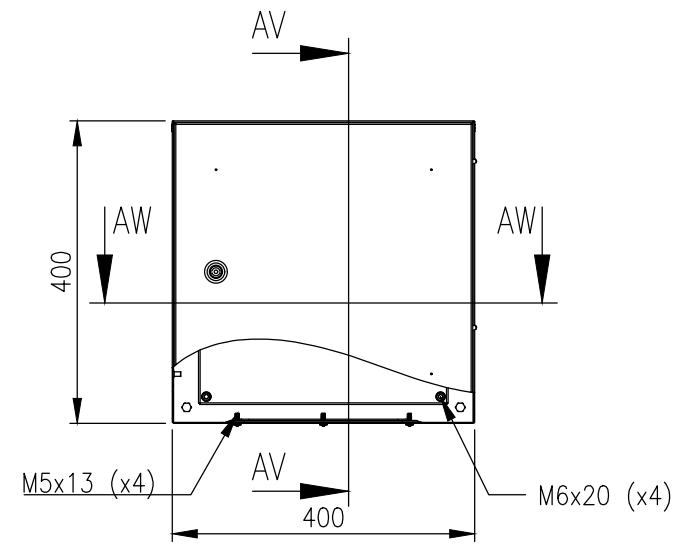

FRONT VIEW

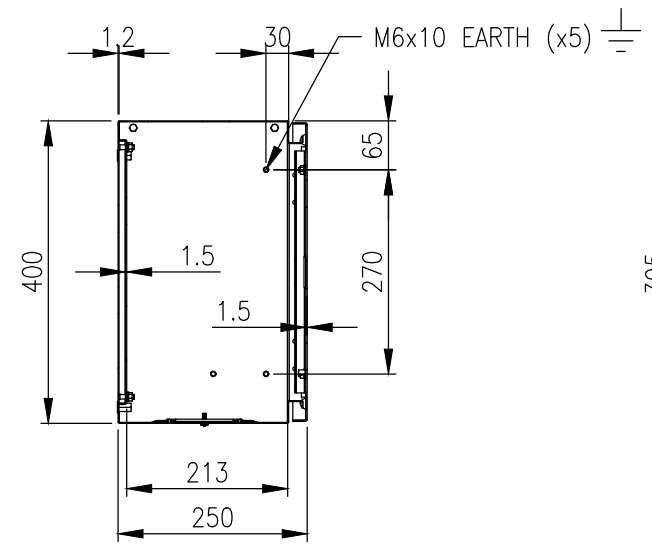

SECTION AV-AV

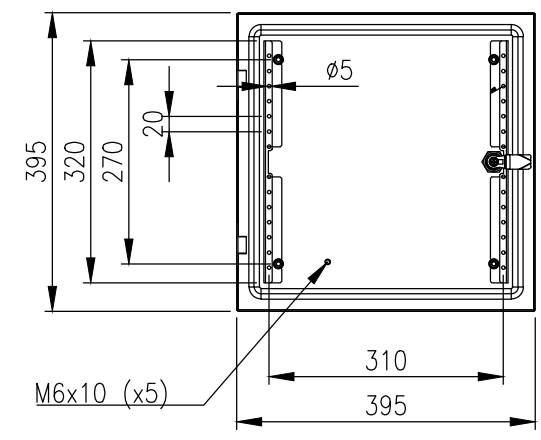

INSIDE DOOR VIEW

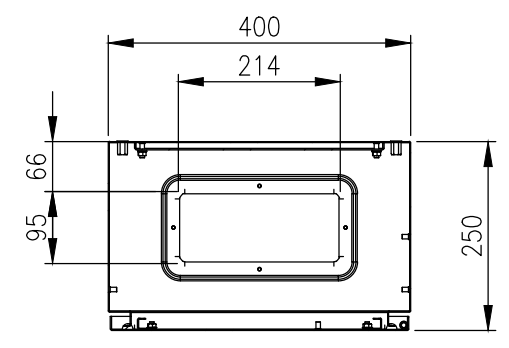
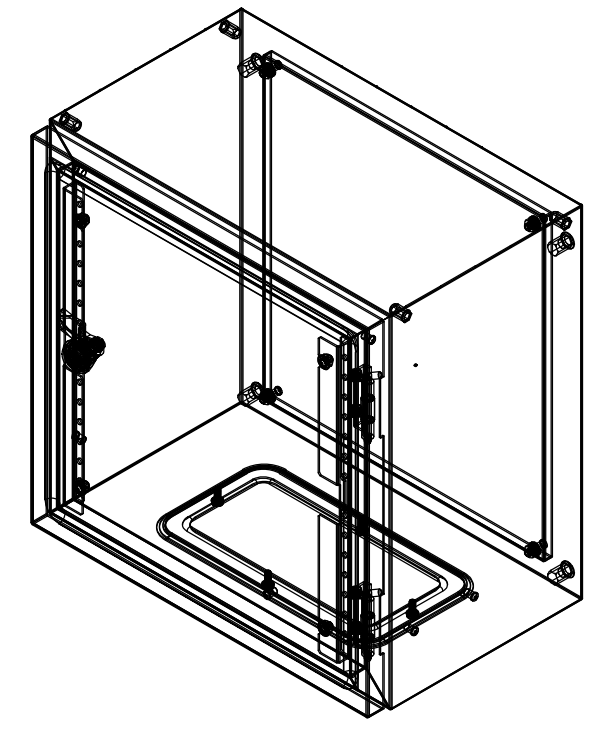

SECTION AW-AW

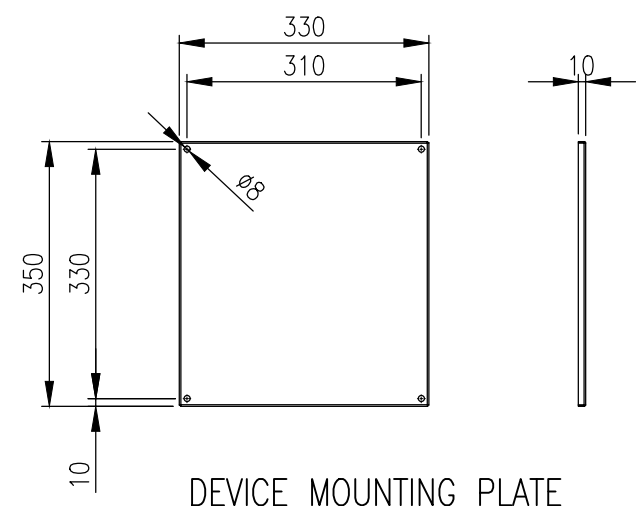

DEVICE MOUNTING PLATE

MATERIAL
 BODY: 1.2mm GALVANISED STEEL SHEET
 DOOR: 1.5mm GALVANISED STEEL SHEET
 DEVICE PLATE: 1.5mm GALVANISED STEEL SHEET
 GLAND PLATE: 1.5mm GALVANISED STEEL SHEET
 SEAL: POLYURETHANE
 SURFACE TREATMENT: POWDER-COAT 80-120micron
 COLOUR: RAL7035 LIGHT GREY

MASS: 10.9Kg.

PROTECTION: IP66 IK10 (NEMA 4)
 STANDARD: IEC/EN62208, IEC/EN/AS60529

© IP ENCLOSURES 2023.
 THIS DRAWING SHALL NOT BE COPIED OR REPRODUCED
 WITHOUT AUTHORISATION FROM IP ENCLOSURES.
 www.ipenclosures.com.au

IMPORTANT NOTE:
 WALL MOUNTING BRACKETS ARE NOT INCLUDED
 AND MUST BE ORDERED SEPARATELY.

Itemref	Quantity	Title/Name, designation, material, dimension etc	Article No./Reference
Designed by IP	Checked by IP	Approved by - date 17/10/23	Filename IP-404025
			400x400x250 STEEL ENCLOSURE
IP-404025			Edition 1
			Sheet 1/1