

TOP VIEW

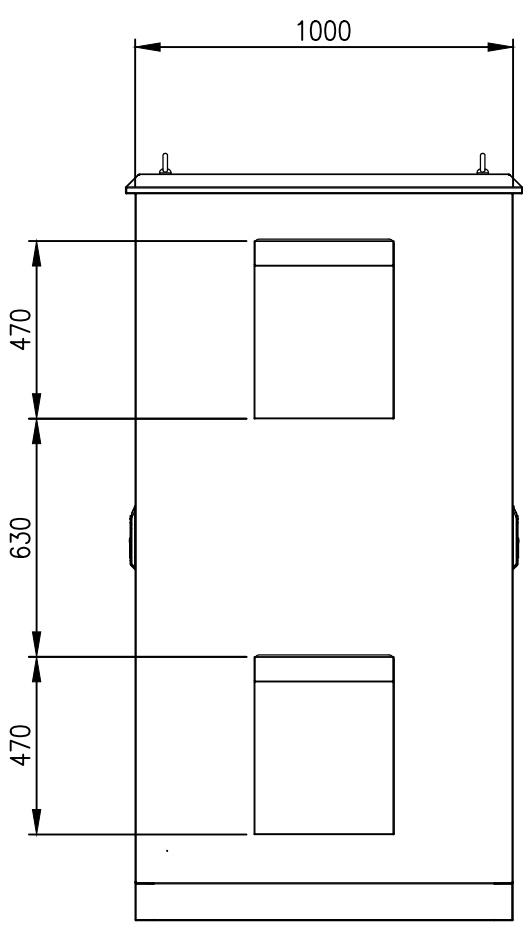

LEFT SIDE VIEW

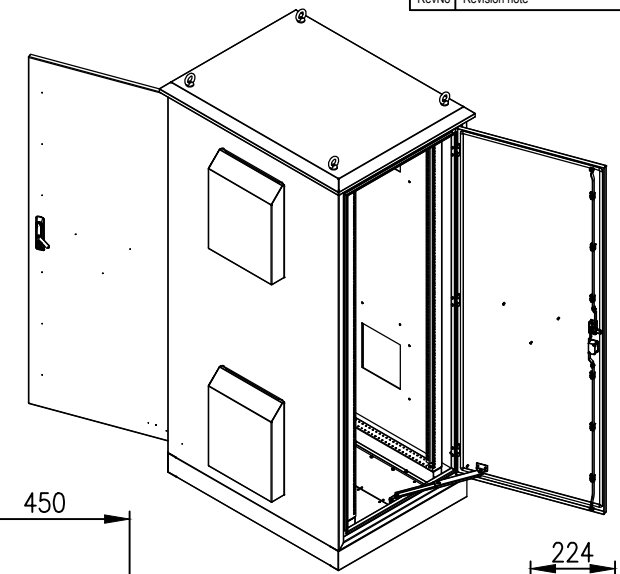
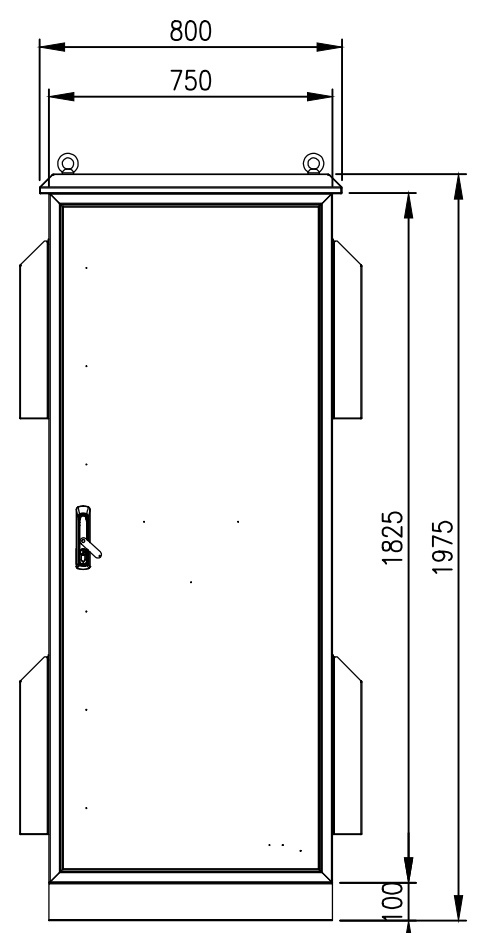

FRONT VIEW

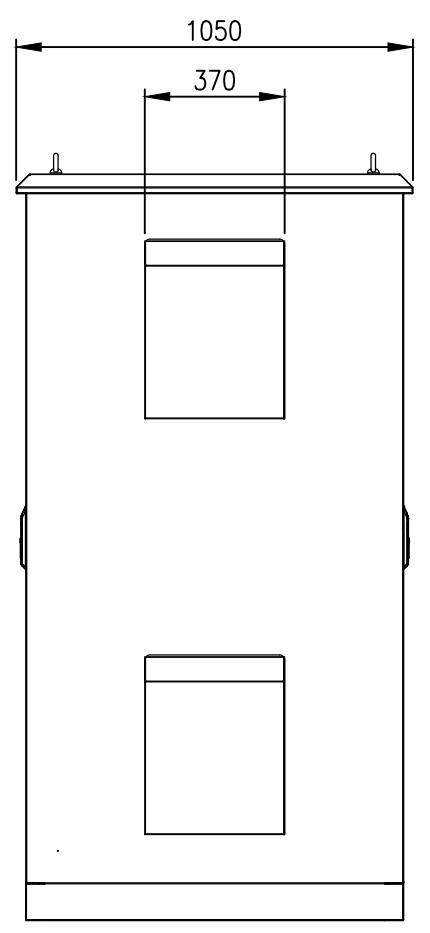

RIGHT SIDE VIEW

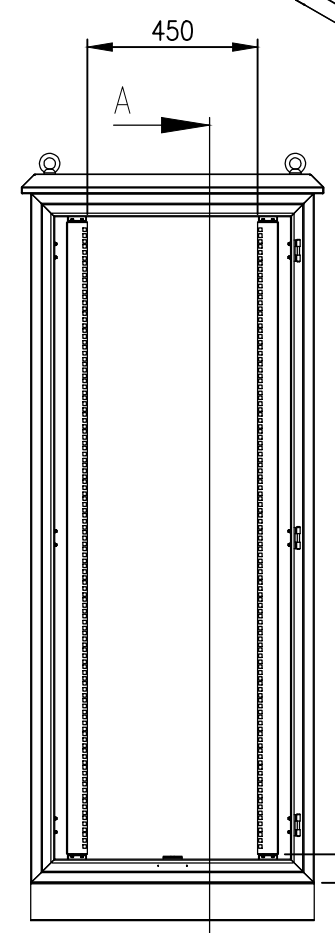

FRONT INTERIOR VIEW
(DOOR REMOVED)

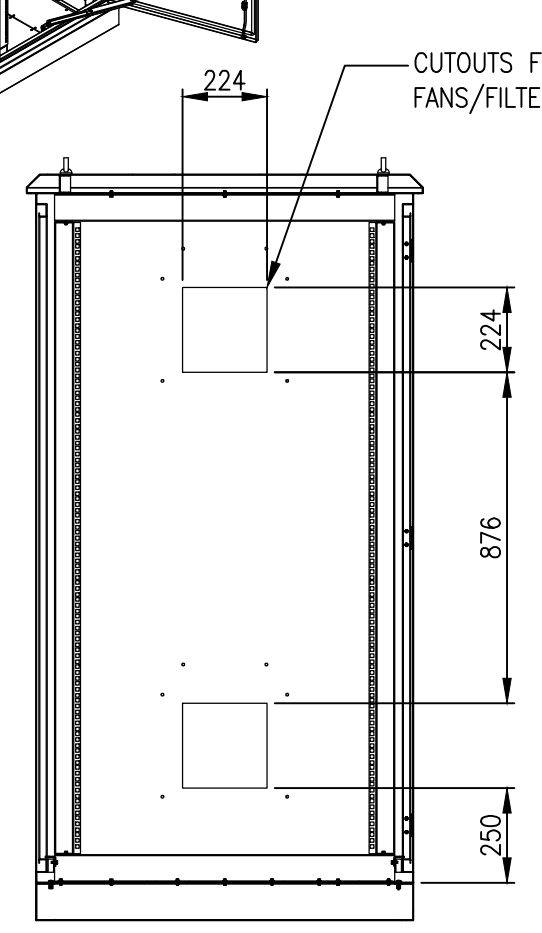

SECTION A-A

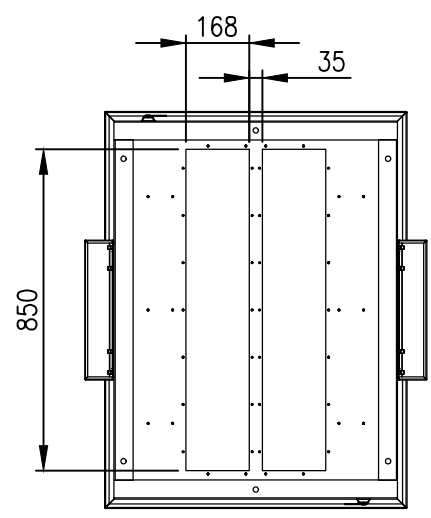

BOTTOM VIEW

MATERIAL
 BODY AND PLINTH: 2.0mm GALVANISED STEEL SHEET
 DOORS: 2.0mm GALVANISED STEEL SHEET
 19" DATA RAILS: 1.5mm GALVANISED STEEL SHEET
 SEAL: POLYURETHANE
 SURFACE TREATMENT: POWDER-COATED 80-120micron
 COLOUR: RAL7035 GREY, SMOOTH FINISH

PROTECTION: IP55 IK10, NEMA 4
 (EXCLUDING FANS/FILTER CUTOUTS)
 STANDARD: IEC62208, IEC/EN/AS60529, EIA-310D

© IP ENCLOSURES 2023.
 THIS DRAWING SHALL NOT BE COPIED OR REPRODUCED
 WITHOUT AUTHORISATION FROM IP ENCLOSURES.
 www.ipenclosures.com.au

Itemref	Quantity	Title/Name, designation, material, dimension etc	Article No./Reference
Designed by	Checked by	Approved by - date	Filename
IP	IP	15/02/23	IP-19775100
Date	Scale		
15/02/23	1:20		
IP Enclosures			36RU IP55 19" CABINET 1975x750x1000
IP-19775100			Edition 0 Sheet 1/1