

RevNo	Revision note	Date	Signature	Checked
3	GENERAL REVISION	18/01/23	IP	IP

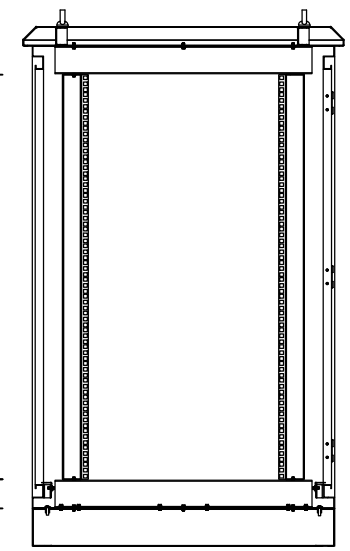
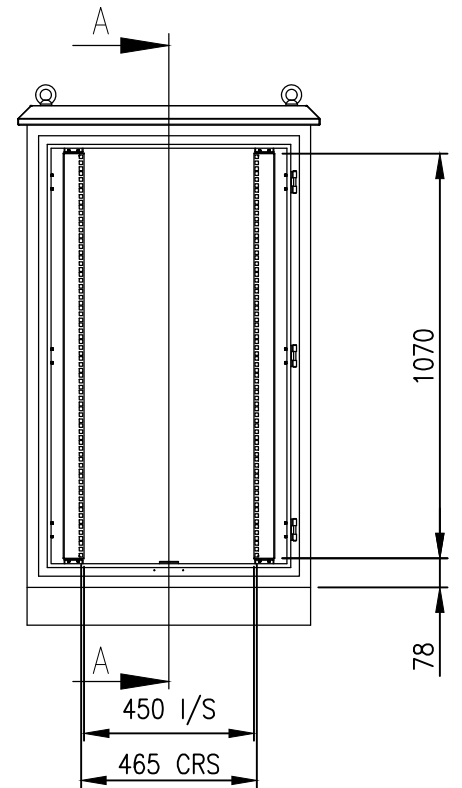
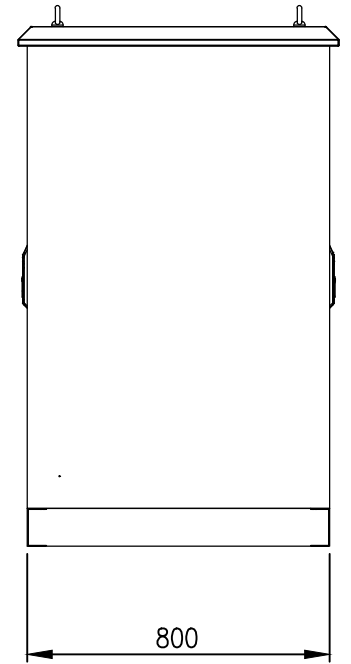
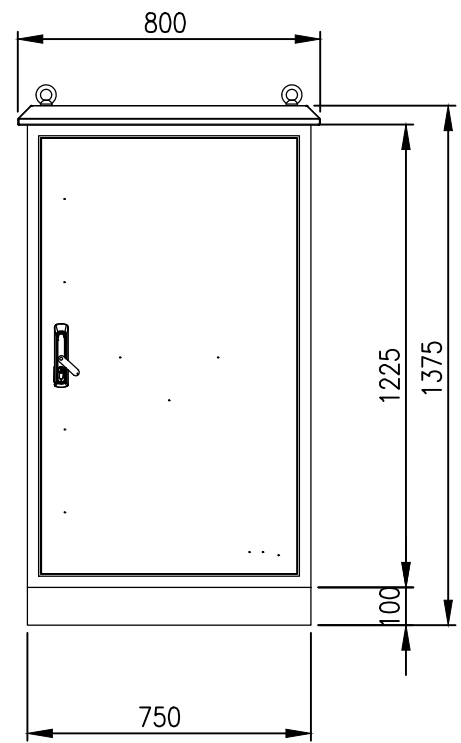
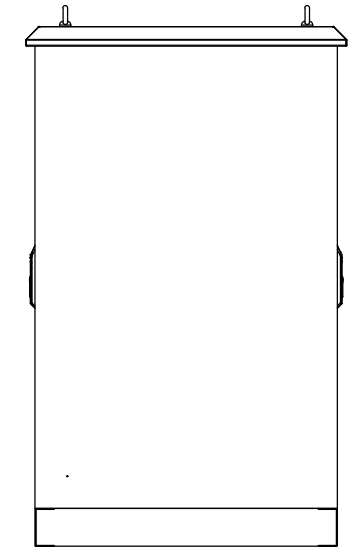
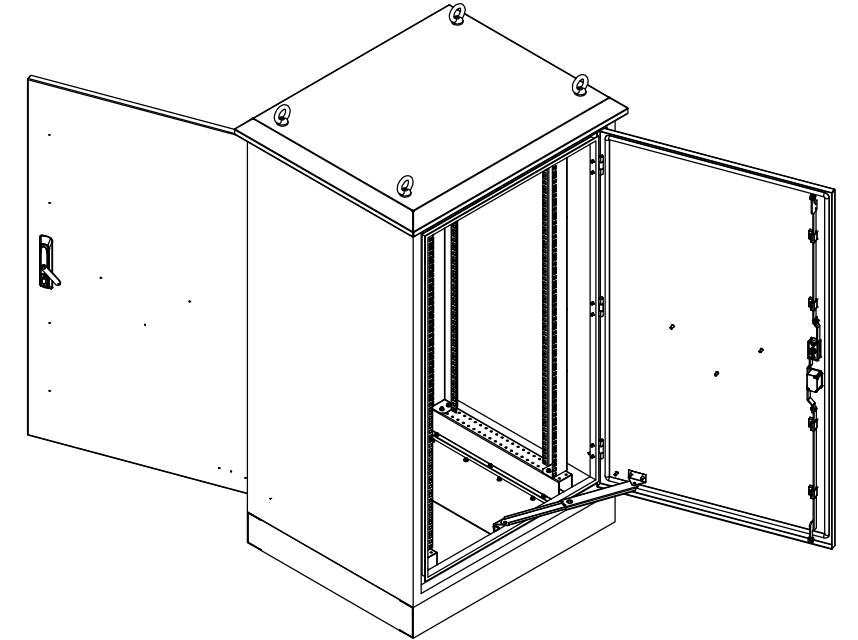
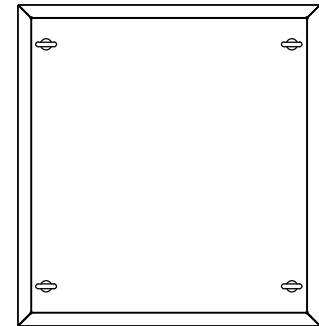

SIDE VIEW

FRONT VIEW
(ASSEMBLY)

SIDE VIEW

FRONT VIEW
(FRONT DOOR REMOVED)

SECTION A-A

MATERIAL
 BODY AND PLINTH: 2.0mm GALVANISED STEEL SHEET
 DOORS: 2.0mm POWDERCOATED GALVANISED SHEET
 19" DATA RAILS: 1.5mm GALVANISED STEEL SHEET
 SEAL: POLYURETHANE
 SURFACE TREATMENT: POWDER-COAT 80-120micron
 COLOUR: RAL7035 LIGHT GREY, SMOOTH FINISH

PROTECTION: IP66
 STANDARD: IEC62208, IEC/EN/AS60529, EIA-310D

© IP ENCLOSURES 2017.
 THIS DRAWING SHALL NOT BE COPIED OR REPRODUCED
 WITHOUT AUTHORISATION FROM IP ENCLOSURES.
 www.ipenclosures.com.au

Itemref	Quantity	Title/Name, designation, material, dimension etc	Article No./Reference
Designed by IP	Checked by IP	Approved by - date 05/06/19	Filename IP-1377580-0 Date 05/06/19 Scale 1:20
			24RU CABINET 1375x750x800 (NO VENTS) IP-1377580-0 Edition 3 Sheet 1/1